

Oppervlakteverwarming en -koeling, installatie-, warmte- en koudedistributiesystemen

Uponor

**Artikellijst Benelux
05-2022**

➤ **START**



Uponor verkorte prijslijst 2022 Benelux

Installatie

Meerlagenleidingsystemen voor drinkwater en verwarmingsinstallatie

Overzicht	4
Uponor meerlagenleidingen	6
Uponor S-Press PLUS	8
Uponor RTM	18
Uponor Uni-X klemkoppelingen ¾"	20
Uponor RS 63-110 mm	22

Meerlagenleidingsystemen voor gasinstallatie

Uponor GAS Press	21
------------------------	----

PE-Xa installatiesystemen voor drinkwater en verwarmingsinstallatie

Uponor leidingen PE-Xa	24
Uponor fittingen Q&E	25
Uponor Aqua PLUS verdeler PPM	28

PE-Xa installatiesystemen voor gasinstallatie

Uponor PE-Xa gasleidingsysteem	29
--------------------------------------	----

Oppervlakteverwarming- en koelsystemen

Oppervlakteverwarming-/koelsystemen via vloer, wand en plafond

Overzicht Uponor systemen	30
Overzicht Uponor leidingen	32

Oppervlakteverwarmingssystemen

Uponor 10 bar UFH vloerverwarming	34
Uponor Minitec	35
Uponor Tecto	36
Uponor Tecto	37
Uponor Nubos	38
Uponor Klett	39
Uponor Tacker	41
Uponor Fix	43
Uponor Classic	44
Uponor Siccus 14	45
Uponor Renovis	46
Uponor Comfort E	47
Uponor Siccus wall	48
Uponor Siccus SW	48
Uponor Thermatop	49

Toebehoren voor oppervlakteverwarmingssystemen	50
Uponor verdeel- en stijgleidingen 25-75 mm	51

Verdelertechniek

Uponor stelaandrijvingen en -adapters	52
Uponor Vario PLUS	53
Uponor Vario M	54
Uponor Vario S	54
Uponor Vario	57

Ruimtetemperatuurregeling

Systeemzoeker Uponor ruimteregeling	58
Uponor Smatrix Wave / Pulse	60
Uponor Smatrix Base / Pulse	61
Uponor Base	62
Uponor Smatrix Base PRO	63
Uponor Vario	63

Aanvoertemperatuurregeling / pompgroepen

Uponor Smatrix Move PRO	64
Uponor Fluvia Move pompgroep	65

Warmte- en koudedistributie

Overzicht Uponor Ecoflex	66
--------------------------------	----

Voorgeïsoleerde leidingen Uponor Ecoflex

Uponor Ecoflex VIP Thermo	70
Uponor Ecoflex Thermo	70
Uponor Ecoflex VIP Aqua	70
Uponor Ecoflex Aqua	70
Uponor Ecoflex Quattro	70
Uponor Ecoflex Supra	71
Uponor Ecoflex Supra PLUS	71
Koppelingen	
Uponor Wipex	72
Uponor Q&E	74
Toebehoren voor Ecoflex leidingsystemen	75

Gereedschappen

Verleggen	77
Vorbereiden, snijden, buigen	77
Persen	79
Expanderen	80
Bevestigen	81

Bijlage

Nieuw in de prijslijst 2022	82
Vervangen artikelen	83
Artikel uitlopend	84

Installatie

Meerlagenleidingsystemen voor drinkwater-, verwarmings- en gasinstallatie

PE-Xa installatiesystemen voor drinkwater-, verwarmings- en gasinstallatie



Installatie

Oppervlakteverwarming-/-koelsystemen

Oppervlakteverwarming-/-koelsystemen via vloer, wand en plafond
Verdelertechniek
Ruimtetemperatuurregeling
Regeling van de aanvoertemperatuur / pompgroepen



Verwarming
en koeling

Warmte- en koudedistributie

Voorgeïsoleerde leidingen voor distributie van verwarmings- en koelwater

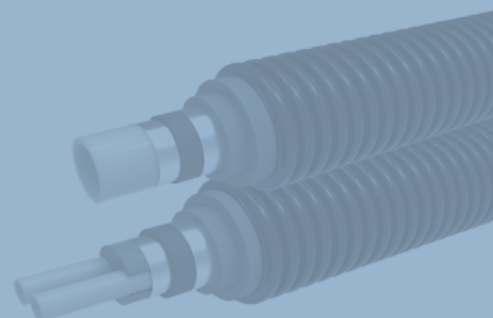

Warmte- en
koudedistributie

Gereedschappen

Verleggen, voorbereiden, snijden, buigen persen, expanderen, bevestigen, overige

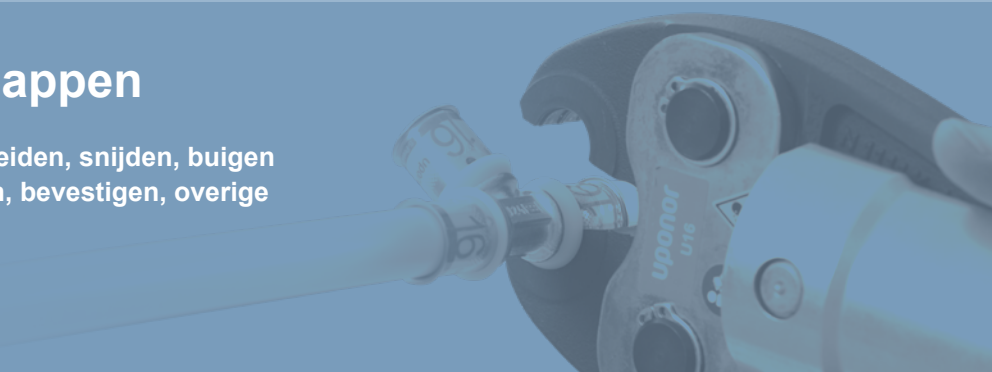

Gereedschappen

Bijlage

Nieuw in de prijslijst 2022
Vervangen artikelen
Artikel uitlopend









Bijlage

Overzicht Uponor installatieleidingen en

Verschillende montagesituaties en toepassingsgebieden verlangen perfect daarop afgestemde fittingconcepten. Daarom ontwikkelt en produceert Uponor niet alleen leidingen, maar tegelijkertijd ook de passende, perfect op de toepassing afgestemde fittingsystemen. Het Uponor fittingprogramma met koppelingen, knieën, bochten, T-stukken en diverse handige systeemcomponenten garandeert een snelle, veilige en doeltreffende montage en overstijgt daarbij de eisen die aan een hygiënische drinkwaterinstallatie en hedendaagse verwarmingsleidingen worden gesteld.

Uponor fittingsysteem	
Afmeting/ Kleurcode	Type meerlagenleiding
 14	MLC
 16	Uni Pipe PLUS
 20	Uni Pipe PLUS
 25	Uni Pipe PLUS
 32	Uni Pipe PLUS
 40	MLC
 50	MLC
 63	MLC
 75	MLC
 90	MLC
 110	MLC
Eigenschappen	
Per diameter een kleurcodering	
Kijkvenster ter controle van de insteekdiepte	
Controle op persing door het verwijderen van de folie van de pershuls	
Controle op persing door de aanslagring die loslaat tijdens de persprocedure	
Controle op persing door persafdruk op pershuls	
Montage zonder ontbramen	
Montage zonder kalibreren	
Verbindingsstuk 'ongeperst niet dicht'	
Geïntegreerde persfunctie	
Modulair fittingsysteem	

verbindingstechniek

Persfitting, metaal				Persfitting, composiet		RTM fitting	Uni-C 1/2"	Uni-X 3/4"
S-Press PLUS	S-Press		RS	S-Press PLUS, PPSU	S-Press PPSU			
								
		•					•	•
•	•		•	•		•	•	•
•			•	•		•	•	•
•			•	•		•		•
•			•	•	•			
		•	•		•			
		•	•		•			
		•	•		•			
			•					
			•					
•	•	•	•	•	•	•		
•	•	•	•	•	•	•		
•			• ²⁾	•				
	•		• ³⁾					
•		•	• ²⁾	•	•			
•	•		• ¹⁾	•		•	•	•
•	•	•	•	•	•		•	•
•	•	•	•	•	•			
			•			•		
			•					

¹⁾ t/m diameter 32
²⁾ vanaf diameter 20
³⁾ diameter 16

Installatie

Verwarming en koeling

Warmte- en koudedistributie

Gereedschappen

Bijlage

Uponor Uni Pipe PLUS

art.nr.	omschrijving	LE	VPE	eenheid
 1060783	16x2,0 3m	75	3	m
1059572	16x2,0 5m	125	5	m
1060784	20x2,25 3m	51	3	m
1059573	20x2,25 5m	85	5	m
1060785	25x2,5 3m	30	3	m
1059574	25x2,5 5m	50	5	m
1060786	32x3,0 3m	21	3	m
1059575	32x3,0 5m	35	5	m

Uponor MLC leiding wit S

 1013448	40x4,0 3m	12	3	m
1088465	40x4,0 3,3m	13,2	3,3	m
1013446	40x4,0 5m	20	5	m
1021980	50x4,5 3m	12	3	m
1088466	50x4,5 3,3m	13,2	3,3	m
1013449	50x4,5 5m	20	5	m
1021981	63x6,0 3m	9	3	m
1013451	63x6,0 5m	15	5	m
1013453	75x7,5 5m	255	5	m
1013455	90x8,5 5m	255	5	m
1013457	110x10,0 5m	165	5	m

Uponor Uni Pipe PLUS wit

 1091638	16x2,0 10m	880	220	m
1091639	16x2,0 25m	1600	400	m
1059576	16x2,0 100m	2000	100	m
1092653	16x2,0 120m	2400	120	m
1059577	16x2,0 200m	2600	200	m
1059578	16x2,0 500m	3500	500	m
1092671	20x2,25 25m	900	225	m
1059579	20x2,25 100m	1300	100	m
1093124	20x2,25 500m	2000	500	m
1059581	25x2,5 50m	700	50	m
1059583	32x3,0 50m	400	50	m

Uponor MLC leiding wit

 1013366	14x2,0 200m	2600	200	m
--	-------------	------	-----	---

art.nr.	omschrijving	LE	VPE	eenheid
 1091709	16x2,0 red	800	100	m
1063553	16x2,0 blue	800	100	m
1091710	20x2,25 red	800	100	m
1063555	20x2,25 blue	800	100	m
1091711	25x2,5 red	400	50	m
1063946	25x2,5 blue	400	50	m
1091712	32x3,0 red	350	50	m
1091716	32x3,0 blue	350	50	m

Uponor MLC leiding wit voorgeïsoleerd S6

 1013577	14x2,0 red	600	50	m
--	------------	-----	----	---

Uponor Uni Pipe PLUS wit voorgeïsoleerd S6 WLS 035

 1063556	16x2,0 blue	600	75	m
1063557	20x2,25 blue	600	75	m
1063558	25x2,5 blue	400	50	m

Uponor Uni Pipe PLUS wit voorgeïsoleerd S6 WLS 040

 1091713	16x2,0 red	600	75	m
1091714	20x2,25 red	600	75	m
1091715	25x2,5 red	400	50	m
1091723	16x2,0 blue	600	75	m
1091724	20x2,25 blue	600	75	m
1091725	25x2,5 blue	400	50	m

Uponor Uni Pipe PLUS wit voorgeïsoleerd S10 WLS 035

 1062181	16x2,0 blue	450	75	m
1062182	20x2,25 blue	525	75	m
1062183	25x2,5 blue	350	50	m

Uponor Uni Pipe PLUS wit voorgeïsoleerd DHS26

 1063562	20x2,25 blue	200	25	m
--	--------------	-----	----	---

Uponor Uni Pipe PLUS

art.nr.	omschrijving	LE	VPE	een- heid
Uponor Uni Pipe PLUS wit in mantelbuis				
 1063061	16x2,0 - 25/20 red	1350	75	m
1063059	16x2,0 - 25/20 blue	1350	75	m
1063062	20x2,25 - 28/23 red	900	75	m
1063060	20x2,25 - 28/23 blue	900	75	m
1093128	25x2,5 - 40/32 red	450	50	m
1093129	25x2,5 - 40/32 blue	450	50	m

Uponor Uni Pipe PLUS in mantelbuis twin

 1091718	16x2,0 - 25/20 black	650	50	m
--	----------------------	-----	----	---

Uponor MLC leiding wit in mantelbuis

 1013678	14x2,0 - 25/20 red	1500	75	m
--	--------------------	------	----	---

art.nr.	omschrijving	LE	VPE	een- heid
Uponor Teck mantelbuis zwart black				
 1012860	25/20	2500	50	m
1012864	28/23	2000	50	m
1012869	35/29	1400	50	m
1012872	43/36	600	25	m

Uponor Teck mantelbuis blauw blue

 1012859	25/20	2500	50	m
1012863	28/23	2000	50	m
1012867	35/29	1400	50	m

Uponor Teck mantelbuis rood red

 1012858	25/20	2500	50	m
1012862	28/23	2000	50	m
1012866	35/29	1400	50	m

Uponor Teck plughaken enkel

 1013137	32 60mm	1000	50	st.
1013138	32 80mm	1000	50	st.

Uponor Teck plughaken dubbel

 1013139	32 60mm	1000	50	st.
1013140	32 80mm	1000	50	st.

Uponor S-Press PLUS PPSU

art.nr.	omschrijving	LE	VPE	eenheid
Uponor S-Press PLUS knie 90° PPSU				
 1039929	16-16	80	20	st.
1039930	20-20	80	10	st.
1039931	25-25	80	10	st.
1039932	32-32	20	5	st.

Uponor S-Press composiet knie 90° PPSU

 1046386	40-40	960	5	st.
1046387	50-50	576	3	st.
1032877	63-63	210	1	st.
1032878	75-75	210	1	st.

Uponor S-Press composiet knie 45° PPSU

 1046388	40-40	960	5	st.
1046389	50-50	576	3	st.
1032879	63-63	192	1	st.
1032880	75-75	192	1	st.

Uponor S-Press PLUS koppeling PPSU

 1039933	16-16	80	20	st.
1039934	20-20	80	10	st.
1039935	25-25	80	10	st.
1039936	32-32	80	10	st.

Uponor S-Press composiet koppeling PPSU

 1046401	40-40	960	5	st.
1046402	50-50	576	3	st.
1032881	63-63	384	1	st.
1032882	75-75	384	1	st.

Uponor S-Press PLUS koppeling verlopend PPSU

 1039937	20-16	80	20	st.
1039938	25-16	80	10	st.
1039939	25-20	80	10	st.
1039940	32-25	80	10	st.

Uponor S-Press koppeling verlopend PPSU

 1039941	40-25	960	5	st.
1039942	40-32	960	5	st.
1039943	50-32	1152	3	st.
1046406	50-40	576	3	st.
1032883	63-40	384	1	st.
1032884	63-50	384	1	st.
1032885	75-50	384	1	st.
1032886	75-63	384	1	st.

art.nr.	omschrijving	LE	VPE	eenheid
Uponor S-Press PLUS T-stuk PPSU				
 1039944	16-16-16	80	10	st.
1039945	20-20-20	80	10	st.
1039946	25-25-25	20	5	st.
1039947	32-32-32	20	5	st.

Uponor S-Press composiet T-stuk PPSU

 1046390	40-40-40	720	5	st.
1046391	50-50-50	288	3	st.
1032887	63-63-63	150	1	st.
1032888	75-75-75	150	1	st.

Uponor S-Press PLUS T-stuk verlopend PPSU

 1039948	16-20-16	80	10	st.
1039949	20-16-16	80	10	st.
1039950	20-16-20	80	10	st.
1039951	20-20-16	80	10	st.
1039952	20-25-20	80	10	st.
1039953	25-16-16	80	10	st.
1039954	25-16-20	80	10	st.
1039955	25-16-25	80	10	st.
1039956	25-20-20	80	10	st.
1039957	25-20-25	80	10	st.
1039958	32-16-32	20	5	st.
1039959	32-20-32	20	5	st.
1039960	32-25-25	20	5	st.
1039961	32-25-32	20	5	st.

Uponor S-Press T-stuk verlopend PPSU

 1039962	40-20-40	960	5	st.
1039963	40-25-32	960	5	st.
1039964	40-25-40	720	5	st.
1039965	40-32-32	960	5	st.
1039966	40-32-40	720	5	st.
1039967	50-25-40	432	3	st.
1039968	50-25-50	432	3	st.
1039969	50-32-50	432	3	st.

Uponor S-Press composiet T-stuk verlopend PPSU

 1046400	50-40-50	288	3	st.
1032889	63-25-63	150	1	st.
1032890	63-32-63	150	1	st.
1032891	63-40-63	150	1	st.
1032892	75-32-75	150	1	st.
1032893	75-40-75	150	1	st.
1032894	75-50-75	150	1	st.

Uponor S-Press PLUS 14

art.nr.	omschrijving	LE	VPE	eenheid
---------	--------------	----	-----	---------

Uponor S-Press puntstuk

	1014513 14-R $\frac{1}{2}$ "MT	80	20	st.
---	---------------------------------------	----	----	-----

Uponor S-Press schroefbus

	1014515 14-Rp $\frac{1}{2}$ "FT	80	20	st.
---	--	----	----	-----

Uponor S-Press koppeling

	1015154 14-14	80	10	st.
---	----------------------	----	----	-----

Uponor S-Press koppeling verlopend

	1015162 16-14	80	20	st.
---	----------------------	----	----	-----

Uponor S-Press T-stuk

	1014886 14-14-14	80	10	st.
---	-------------------------	----	----	-----

Uponor S-Press T-stuk verlopend

	1014888 14-16-14	80	10	st.
	1014912 16-14-14	80	10	st.
	1014915 16-14-16	80	10	st.

art.nr.	omschrijving	LE	VPE	eenheid
---------	--------------	----	-----	---------

Uponor S-Press koppeling overgangskoppeling koper/RVS

	1014511 14-15CU	80	10	st.
---	------------------------	----	----	-----

Uponor Smart Aqua muurplaat S-Press

	1015437 14-Rp $\frac{1}{2}$ "FT	40	10	st.
---	--	----	----	-----

Uponor Smart Aqua overgangsknie S-Press

	1014654 14-12CU l=150mm	2880	20	st.
--	--------------------------------	------	----	-----

Uponor Smart Radi aansluitknie S-Press

	1015615 14-15CU l=350mm	640	20	st.
---	--------------------------------	-----	----	-----

Uponor S-Press PLUS

art.nr.	omschrijving	LE	VPE	eenheid
Uponor S-Press PLUS puntstuk				
 1070501	16-R $\frac{3}{8}$ "MT	80	20	st.
1070502	16-R $\frac{1}{2}$ "MT	80	20	st.
1070503	16-R $\frac{3}{4}$ "MT	120	15	st.
1070504	20-R $\frac{1}{2}$ "MT	80	20	st.
1070505	20-R $\frac{3}{4}$ "MT	80	10	st.
1070506	20-R1"MT	80	10	st.
1070507	25-R $\frac{3}{4}$ "MT	80	10	st.
1070508	25-R1"MT	40	5	st.
1070509	32-R1"MT	40	5	st.
1070510	32-R1 $\frac{1}{4}$ "MT	20	5	st.

Uponor S-Press puntstuk

 1046901	40-R1 $\frac{1}{4}$ "MT	960	5	st.
1046902	40-R1 $\frac{1}{2}$ "MT	960	5	st.
1046905	50-R1 $\frac{1}{2}$ "MT	1152	3	st.
1046906	50-R2"MT	576	3	st.
1032895	63-R2"MT	336	1	st.
1032896	75-R2 $\frac{1}{2}$ "MT	336	1	st.

Uponor S-Press PLUS overgangskoppeling BENELUX

 1070511	16-R15mm CU	80	20	st.
1070512	20-R22mm CU	3840	10	st.
1070513	25-R22mm CU	3840	10	st.

Uponor S-Press PLUS schroefbus

 1070515	16-Rp $\frac{1}{2}$ "FT	80	20	st.
1070516	20-Rp $\frac{1}{2}$ "FT	120	15	st.
1070517	20-Rp $\frac{3}{4}$ "FT	80	10	st.
1070518	20-Rp1"FT	80	20	st.
1070519	25-Rp $\frac{3}{4}$ "FT	40	5	st.
1070520	25-Rp1"FT	40	5	st.
1070521	32-Rp1"FT	40	5	st.
1070522	32-Rp1 $\frac{1}{4}$ "FT	20	5	st.

Uponor S-Press schroefbus

 1046903	40-Rp1 $\frac{1}{4}$ "FT	960	5	st.
1046904	40-Rp1 $\frac{1}{2}$ "FT	960	5	st.
1046907	50-Rp1 $\frac{1}{2}$ "FT	1152	3	st.

Uponor S-Press PLUS knie 90°

 1070523	16-16	80	20	st.
1070524	20-20	80	10	st.
1070525	25-25	40	5	st.
1070526	32-32	20	5	st.

art.nr.	omschrijving	LE	VPE	eenheid
Uponor S-Press knie 90°				
 1046908	40-40	600	5	st.
1046911	50-50	240	3	st.

Uponor S-Press PLUS bocht 90°

 1070527	16-16	80	10	st.
1070528	20-20	80	10	st.
1070529	25-25	40	5	st.
1070530	32-32	20	5	st.

Uponor S-Press PLUS knie 90° buitendraad

 1070531	16-R $\frac{3}{8}$ "MT	80	20	st.
1070532	16-R $\frac{1}{2}$ "MT	80	20	st.
1070533	20-R $\frac{1}{2}$ "MT	80	10	st.
1070534	20-R $\frac{3}{4}$ "MT	80	10	st.
1070535	25-R $\frac{3}{4}$ "MT	40	5	st.
1070536	25-R1"MT	40	5	st.
1070537	32-R1"MT	20	5	st.

Uponor S-Press knie 90° buitendraad

 1046909	40-R1 $\frac{1}{4}$ "MT	500	5	st.
--	-------------------------	-----	---	-----

Uponor S-Press PLUS kniekoppeling klemovergang koper

 1070538	16-G $\frac{3}{8}$ "MT/10CU	20	1	st.
--	-----------------------------	----	---	-----

Uponor S-Press PLUS knie 90° binnendraad

 1070539	16-Rp $\frac{1}{2}$ "FT	80	10	st.
1070540	20-Rp $\frac{1}{2}$ "FT	80	10	st.
1070541	20-Rp $\frac{3}{4}$ "FT	40	10	st.
1070542	25-Rp $\frac{3}{4}$ "FT	20	5	st.
1070543	25-Rp1"FT	20	5	st.
1070544	32-Rp1"FT	20	5	st.

Uponor S-Press knie 90° binnendraad

 1046910	40-Rp1 $\frac{1}{2}$ "FT	500	5	st.
1046912	50-Rp1 $\frac{1}{2}$ "FT	300	3	st.

Uponor S-Press PLUS

art.nr.	omschrijving	LE	VPE	eenheid
---------	--------------	----	-----	---------

Uponor S-Press PLUS knie 45°

 1070545	25-25	20	5	st.
1070546	32-32	20	5	st.

Uponor S-Press knie 45°

 1046913	40-40	500	5	st.
1046914	50-50	300	3	st.

Uponor S-Press PLUS koppeling

 1070547	16-16	80	20	st.
1070548	20-20	80	10	st.
1070549	25-25	80	10	st.
1070550	32-32	40	5	st.

Uponor S-Press PLUS schuifkoppeling

 1118706	16-16	80	10	st.
1118707	20-20	80	10	st.
1118708	25-25	40	5	st.
1118709	32-32	20	5	st.
1118710	40-40	12	3	st.

Uponor S-Press koppeling

 1046932	40-40	960	5	st.
1046935	50-50	576	3	st.

Uponor S-Press PLUS koppeling verlopend

 1070552	20-16	80	20	st.
1070553	25-16	80	10	st.
1070554	25-20	80	10	st.
1070555	32-20	80	10	st.
1070556	32-25	80	10	st.

Uponor S-Press koppeling verlopend

 1046930	40-25	960	5	st.
1046931	40-32	960	5	st.
1046933	50-32	1152	3	st.
1046934	50-40	576	3	st.

art.nr.	omschrijving	LE	VPE	eenheid
---------	--------------	----	-----	---------

Uponor S-Press PLUS T-stuk

 1070560	16-16-16	80	10	st.
1070561	20-20-20	80	10	st.
1070562	25-25-25	20	5	st.
1070563	32-32-32	20	5	st.

Uponor S-Press T-stuk

 1046921	40-40-40	400	5	st.
1046928	50-50-50	300	3	st.

Uponor S-Press PLUS T-stuk verlopend

 1070566	16-20-16	80	10	st.
1070567	20-16-16	40	10	st.
1070568	20-16-20	80	20	st.
1070569	20-20-16	80	20	st.
1070570	20-25-16	40	10	st.
1070571	20-25-20	40	10	st.
1070572	25-16-16	40	5	st.
1070573	25-16-20	40	5	st.
1070574	25-16-25	20	5	st.
1070575	25-20-16	40	5	st.
1070576	25-20-20	40	5	st.
1070577	25-20-25	20	5	st.
1070578	25-25-16	20	5	st.
1070579	25-32-25	20	5	st.
1070580	32-16-32	20	5	st.
1070581	32-20-32	20	5	st.
1070582	32-25-25	20	5	st.
1070583	32-25-32	20	5	st.

Uponor S-Press T-stuk verlopend

 1046916	40-20-40	400	5	st.
1046917	40-25-32	500	5	st.
1046918	40-25-40	400	5	st.
1046919	40-32-32	400	5	st.
1046920	40-32-40	400	5	st.
1046924	50-25-40	300	3	st.
1046925	50-25-50	240	3	st.
1046926	50-32-50	300	3	st.
1046927	50-40-50	300	3	st.

Uponor S-Press PLUS T-stuk buitendraad

 1070592	16-R $\frac{1}{2}$ \"MT-16	40	10	st.
1070593	25-R $\frac{3}{4}$ \"MT-25	20	5	st.
1070594	32-R $\frac{3}{4}$ \"MT-32	20	5	st.

Uponor S-Press PLUS

art.nr.	omschrijving	LE	VPE	eenheid
Uponor S-Press PLUS T-stuk binnendraad				
 1070595	16-Rp½"FT-16	40	10	st.
1070596	20-Rp½"FT-20	60	15	st.
1070597	20-Rp¾"FT-20	40	10	st.
1070598	25-Rp½"FT-25	20	5	st.
1070599	25-Rp¾"FT-25	20	5	st.
1070600	32-Rp½"FT-32	20	5	st.
1070601	32-Rp¾"FT-32	20	5	st.

art.nr.	omschrijving	LE	VPE	eenheid
Uponor S-Press T-stuk binnendraad				
 1046922	40-Rp½"FT-40	500	5	st.
1046923	40-Rp¾"FT-40	400	5	st.
1046929	50-Rp1"FT-50	240	3	st.

art.nr.	omschrijving	LE	VPE	eenheid
Uponor S-Press PLUS schroefkoppeling met wartel binnendraad				
 1070708	16-G¾"SN	25	1	st.
1070602	16-G½"SN	30	1	st.
1070603	16-G¾"SN	20	1	st.
1070604	20-G½"SN	20	1	st.
1070605	20-G¾"SN	20	1	st.
1070606	25-G¾"SN	15	1	st.
1070607	25-G1"SN	15	1	st.
1070608	25-G1 ¼"SN	10	1	st.
1070609	32-G1"SN	10	1	st.
1070610	32-G1 ¼"SN	10	1	st.

art.nr.	omschrijving	LE	VPE	eenheid
Uponor S-Press schroefkoppeling met wartel binnendraad				
 1060094	40-G1 ¼"SN	960	5	st.
1046937	40-G1 ½"SN	960	5	st.
1060095	50-G1 ½"SN	1152	3	st.
1046938	50-G1 ¾"SN	1152	3	st.
1046939	50-G2"SN	576	3	st.

art.nr.	omschrijving	LE	VPE	eenheid
Uponor S-Press PLUS kniekoppeling met wartel binnendraad				
 1070611	16-G¾"SN	20	1	st.
1070612	16-G½"SN	20	1	st.
NEW 1105818	16-G¾"SN	10	1	st.
1070613	20-G½"SN	20	1	st.
NEW 1105819	20-G¾"SN	10	1	st.
1070614	25-G¾"SN	10	1	st.

art.nr.	omschrijving	LE	VPE	eenheid
Uponor S-Press PLUS muurplaat M				
 1070638	16-Rp¾"FT	40	10	st.
1070639	16-Rp½"FT	40	10	st.
1070640	20-Rp½"FT	40	10	st.
1070641	20-Rp¾"FT	20	5	st.
1070642	25-Rp¾"FT	20	5	st.

art.nr.	omschrijving	LE	VPE	eenheid
Uponor S-Press PLUS muurplaat lang L				
 1070644	16-Rp½"FT	40	10	st.
1070645	20-Rp½"FT	40	10	st.

art.nr.	omschrijving	LE	VPE	eenheid
Uponor S-Press PLUS muurplaat XL				
 1070646	16-Rp½"FT	40	10	st.
1070647	20-Rp½"FT	40	10	st.

art.nr.	omschrijving	LE	VPE	eenheid
Uponor S-Press PLUS geluidsset 2 wandpanelen				
 NEW 1121193	16-20	192	1	set

art.nr.	omschrijving	LE	VPE	eenheid
Uponor S-Press PLUS wandrozet muurplaat				
 1070643	16-Rp¾"FT	20	1	st.

art.nr.	omschrijving	LE	VPE	eenheid
Uponor S-Press PLUS muurplaat Gemini				
 1070665	16-Rp½"FT	4800	75	st.

art.nr.	omschrijving	LE	VPE	eenheid
Uponor S-Press PLUS U-muurplaat				
 1070629	16-Rp½"FT-16	20	5	st.
1070630	20-Rp½"FT-20	960	5	st.
1070631	20-Rp½"FT-16	960	5	st.
1070632	16-Rp½"FT-20	960	5	st.
1070633	25-Rp½"FT-25	576	3	st.
1070634	25-Rp½"FT-20	576	3	st.
1070635	20-Rp½"FT-25	576	3	st.

art.nr.	omschrijving	LE	VPE	eenheid
Uponor S-Press PLUS geluidsset U-muurpaneel				
 NEW 1121194	16-20	384	1	st.

Uponor S-Press PLUS

art.nr.	omschrijving	LE	VPE	een- heid
---------	--------------	----	-----	--------------

Uponor S-Press PLUS U-aansluiting

	1070636 16-16-R $\frac{1}{2}$ "MT	960	5	st.
	1070637 20-20-R $\frac{3}{4}$ "MT	960	5	st.

Uponor S-Press PLUS muurplaat twin 90° lang

	1070648 16-Rp $\frac{1}{2}$ "FT-16	40	10	st.
	1070649 20-Rp $\frac{1}{2}$ "FT-20	40	10	st.

Uponor Smart Aqua aansluitboxset S-Press



1092771	16-Rp $\frac{1}{2}$ "FT blue x2, red x2	9	1	set
1092772	20-Rp $\frac{1}{2}$ "FT blue x2, red x2	9	1	set

art.nr.	omschrijving	LE	VPE	een- heid
---------	--------------	----	-----	--------------

Uponor S-Press PLUS aansluitadapter 90°

	1070657 16-Rp $\frac{1}{2}$ "FT	10	1	st.
---	--	----	---	-----

Uponor S-Press PLUS SK-T-stuk Geberit

	1070659 16-G $\frac{1}{2}$ "FT-16	10	1	st.
---	--	----	---	-----

Uponor S-Press PLUS SK-knie Geberit

	1070658 16- $\frac{1}{2}$ "FT	80	20	st.
---	--------------------------------------	----	----	-----

Uponor Smart Aqua SK-schroefkoppeling Geberit

	1058097 16- $\frac{1}{2}$ "FT	25	1	st.
---	--------------------------------------	----	---	-----

Uponor S-Press PLUS eindkap

	1070621 16	160	40	st.
	1070622 20	7680	20	st.
	1070623 25	3840	10	st.
	1070624 32	1920	5	st.

Uponor MLC afperskoppeling

	1013754 14	7680	20	st.
	1013756 16	7680	20	st.
	1013760 20	3840	20	st.
	1013762 25	3840	10	st.
	1013764 32	3840	10	st.
	1013765 40	960	5	st.

Uponor MLC o-ring voor afperskoppeling

	1013798 14	10000	10	st.
	1013799 16	1000	10	st.
	1013801 20	1000	10	st.
	1013802 25	500	10	st.
	1013803 32	500	10	st.
	1013804 40	10000	10	st.

Uponor S-Press PLUS

art.nr.	omschrijving	LE	VPE	eenheid
---------	--------------	----	-----	---------

Uponor S-Press PLUS montagebeugel geluid geïsoleerd USP

 NEW 1070666	16-Rp½"FT c/c150mm	150	5	st.
--	--------------------	-----	---	-----

Uponor S-Press PLUS montagebeugel set

 1070661	16-Rp½"FT c/c80mm	5	1	st.
1070662	16-Rp½"FT c/c150mm	380	5	st.

Uponor S-Press PLUS montagebeugel set Gemini

 1070663	16-Rp½"FT c/c120mm	720	5	st.
1070664	16-Rp½"FT c/c150mm	720	5	st.

Uponor S-Press PLUS knie overgangsstuk

 1070650	16-15CU l=150mm	2880	20	st.
1070651	16-12CU l=150mm	2880	20	st.

Uponor S-Press PLUS wanddoorvoer recht

 1070652	16-G½"FT	5	1	st.
---	----------	---	---	-----

Uponor S-Press PLUS wanddoorvoer 90° LWC

 1070653	16-Rp½"FT l=25	5	1	st.
1070654	16-Rp½"FT l=35	5	1	st.

Uponor S-Press PLUS U-wanddoorvoer 90° LWC

 1070655	16-Rp½"FT-16 l=25	5	1	st.
1070656	16-Rp½"FT-16 l=35	5	1	st.

Uponor Smart Aqua afdichtingspakking LWC

 OUT 1084151		50	10	st.
--	--	----	----	-----

OUT Artikel is uitlopend.
Levering zolang de voorraad strekt.

art.nr.	omschrijving	LE	VPE	eenheid
---------	--------------	----	-----	---------

Uponor S-Press PLUS montageplaat

 NEW 1121197	80/150mm	5	1	st.
--	----------	---	---	-----

Uponor S-Press PLUS montagebeugel

 NEW 1121196	100mm	5	1	st.
NEW 1121195	80/150mm	5	1	st.

Uponor Smart Aqua montagebeugel Gemini

 1059824	120mm	5	1	st.
1059825	150mm	5	1	st.

Uponor Smart Aqua enkele montagebeugel

 1057843		5	1	st.
---	--	---	---	-----

Uponor Smart Aqua monterail

 1057844	2m	10	1	st.
--	----	----	---	-----

Uponor Smart Aqua buigtang voor montageplaat

 1015424	2m	100	1	st.
---	----	-----	---	-----

Uponor Smart Aqua lockpin schroeven (10 st.)

 1057847		-	1	set
---	--	---	---	-----

Speciepluggen Nathan ½ buitendraad

 50003600	rood	-	200	st.
50003500	blauw	-	200	st.

LET OP: afname per verpakkingseenheid van 200 st. en/of een veelvoud daarvan.

Uponor S-Press PLUS

art.nr.	omschrijving	LE	VPE	eenheid
---------	--------------	----	-----	---------

art.nr.	omschrijving	LE	VPE	eenheid
---------	--------------	----	-----	---------

Uponor S-Press PLUS overgangskoppeling

Uponor S-Press overgangskoppeling SST-CU V

 1090678	16-15CU-SST	10	1	st.
1090679	20-22CU-SST	5	1	st.
1090680	25-22CU-SST	5	1	st.
1090681	32-28CU-SST	5	1	st.

Uponor S-Press overgangskoppeling SST-CU M

 1090682	16-15CU-SST	10	1	st.
1090683	20-22CU-SST	5	1	st.
1090684	25-22CU-SST	5	1	st.
1090685	32-28CU-SST	5	1	st.

Uponor S-Press PLUS overgang koper/RVS

 1070705	16-10CU	80	20	st.
1070706	16-12CU	80	20	st.
1070615	16-15CU	160	20	st.
1070707	20-15CU	3840	10	st.
1070616	20-18CU	40	10	st.
1070617	20-22CU	60	15	st.
1070618	25-22CU	20	5	st.
1070619	25-28CU	1920	5	st.
1070620	32-28CU	20	5	st.

Uponor S-Press koppeling verlopend

 1015172	18-16	80	20	st.
1015185	20-18	80	10	st.

Uponor S-Press PLUS RVS

Uponor S-Press SST puntstuk

 OUT 1090686	16-R $\frac{1}{2}$ "MT	10	1	st.
OUT 1090687	20-R $\frac{3}{4}$ "MT	10	1	st.
OUT 1090688	25-R $\frac{3}{4}$ "MT	5	1	st.

Uponor S-Press SST schroefbus

 OUT 1090689	25-Rp $\frac{3}{4}$ "FT	5	1	st.
OUT 1090690	32-Rp1"FT	5	1	st.

Uponor S-Press overgangskoppeling SST

 1089056	16-15SST	10	1	st.
1089057	20-22SST	10	1	st.
1089058	25-22SST	5	1	st.
1089059	32-28SST	5	1	st.

Uponor Smart Aqua U-muurplaat SST S-Press

 OUT 1090691	16-Rp $\frac{1}{2}$ "FT-16	5	1	st.
OUT 1090692	20-Rp $\frac{1}{2}$ "FT-20	5	1	st.

Uponor Smart Aqua muurplaat SST S-Press





 OUT 1090693	16-Rp $\frac{1}{2}$ "FT	10	1	st.
OUT 1090694	20-Rp $\frac{1}{2}$ "FT	10	1	st.

OUT Artikel is uitlopend.
Levering zolang de voorraad strekt.



Uponor S-Press PLUS verwarming

art.nr.	omschrijving	LE	VPE	eenheid
Uponor S-Press PLUS Radi kruisfitting				
 1070685	16-16-16	192	1	st.
1070686	20-16-16	192	1	st.
1070687	20-16-20	192	1	st.
1070688	20-20-20	192	1	st.



Uponor S-Press PLUS Radi kruisfitting geïsoleerd

 1070689	16-16-16	192	1	st.
 1070690	20-16-16	192	1	st.
 1070691	20-16-20	192	1	st.
 1070692	20-20-20	192	1	st.



Uponor Smart Radi radiator aansluitblok







 1013134	16 h=215mm	240	10	st.
 1007077	16 h=240mm	240	10	st.

Uponor S-Press PLUS knie overgangsstuk verchromd

 1070678	16-15CU l=350mm	1680	20	st.
 1070679	16-15CU l=1000mm	400	20	st.
 1070680	25-22CU l=250mm	640	20	st.

Uponor S-Press PLUS T-overgangsstuk verchromd



 1070681	16-15CU-16 l=350mm	600	20	st.
 1070682	20-15CU-20 l=350mm	600	20	st.

art.nr.	omschrijving	LE	VPE	eenheid
Uponor S-Press PLUS plintaansluiting				
 1070693	16-G $\frac{1}{2}$ "MT-16	192	1	st.
 1070694	16-G $\frac{1}{2}$ "MT-20	192	1	st.
 1070695	16-G $\frac{1}{2}$ "MT-0	192	1	st.
 1070696	20-G $\frac{1}{2}$ "MT-16	192	1	st.
 1094219	0-G $\frac{1}{2}$ "MT-16	192	1	st.
 1070697	20-G $\frac{1}{2}$ "MT-20	192	1	st.

Uponor Smart Base SL-knie SL

 1014060	15x1	25	1	set
--	------	----	---	-----

Uponor S-Press PLUS montageplaatset radi

 1070683	16-Rp $\frac{1}{2}$ "FT c/c35mm	720	5	st.
 1070684	16-Rp $\frac{1}{2}$ "FT c/c50mm	720	5	st.

Uponor S-Press PLUS verwarming

art.nr.	omschrijving	LE	VPE	een- heid
---------	--------------	----	-----	--------------

Uponor Smart Radi schroefaansluitpijp



1015425	G½"MT-15CU l=350mm	640	20	st.
---------	--------------------	-----	----	-----

Uponor Smart Radi klemkoppeling elastisch



1013830	15CU-¾" Euro	80	10	st.
---------	--------------	----	----	-----

Uponor Smart Radi radiatoraansluitnippel



1013906	G¾"MT-G½"MT	80	10	st.
---------	-------------	----	----	-----

Uponor Smart Radi schroefkoppeling Danfoss



1013970	16-G½"MT	20	1	st.
---------	----------	----	---	-----

Uponor Smart Radi schroefkoppeling Heimeier



1013978	16-G½"MT	20	1	st.
---------	----------	----	---	-----

Uponor Smart Radi schroefkoppeling Oventrop



1014016	16-G½"MT	20	1	st.
---------	----------	----	---	-----

Uponor Smart Radi radiatoraansluitset 16



1011364		100	10	st.
---------	--	-----	----	-----

Uponor Smart Radi rozet, wit



1011370	16 white	20000	50	st.
---------	----------	-------	----	-----

Uponor Smart Radi dubbelrozet, wit



1011373	14-20 white double	500	50	st.
---------	--------------------	-----	----	-----

art.nr.	omschrijving	LE	VPE	een- heid
---------	--------------	----	-----	--------------

Uponor S-Press inregelafsluiter Aquastrom T plus



1013243	G¾"MT	300	1	st.
---------	-------	-----	---	-----

Uponor RTM

art.nr.	omschrijving	LE	VPE	eenheid
Uponor RTM knie 90° PPSU				
 1048547	16-16	40	1	st.
1048548	20-20	25	1	st.
1048549	25-25	15	1	st.

Uponor RTM koppeling PPSU				
 1048542	16-16	40	1	st.
1048543	20-20	30	1	st.
1048544	25-25	20	1	st.

Uponor RTM koppeling verlopend PPSU				
 1048545	20-16	35	1	st.
1048546	25-20	25	1	st.

Uponor RTM T-stuk PPSU				
 1048550	16-16-16	24	1	st.
1048551	20-20-20	20	1	st.
1048552	25-25-25	10	1	st.

Uponor RTM T-stuk verlopend PPSU				
 1048553	20-16-20	20	1	st.
1048554	20-16-16	20	1	st.
1048555	20-20-16	20	1	st.
1048556	25-20-25	14	1	st.
1048557	25-20-20	14	1	st.

Uponor RTM puntstuk				
 1048566	16-R $\frac{1}{2}$ "MT	48	1	st.
1048567	20-R $\frac{1}{2}$ "MT	36	1	st.
1048568	20-R $\frac{3}{4}$ "MT	25	1	st.
1048569	25-R $\frac{3}{4}$ "MT	20	1	st.
1048570	25-R1"MT	20	1	st.

Uponor RTM koppeling v. klemaansluiting BENELUX				
 1062842	16-15mm	10	1	st.
1062843	20-22mm	10	1	st.
1062844	25-22mm	5	1	st.

art.nr.	omschrijving	LE	VPE	eenheid
Uponor RTM schroefbus				
 1048581	16-Rp $\frac{1}{2}$ "FT	48	1	st.
1048582	20-Rp $\frac{1}{2}$ "FT	36	1	st.
1048583	20-Rp $\frac{3}{4}$ "FT	25	1	st.
1048584	25-Rp $\frac{3}{4}$ "FT	25	1	st.
1048585	25-Rp1"FT	20	1	st.

Uponor RTM knie 90° buitendraad				
 1048599	16-R $\frac{1}{2}$ "MT	30	1	st.
1048600	20-R $\frac{1}{2}$ "MT	20	1	st.
1048601	20-R $\frac{3}{4}$ "MT	20	1	st.
1048602	25-R $\frac{3}{4}$ "MT	15	1	st.

Uponor RTM knie 90° binnendraad				
 1048590	16-Rp $\frac{1}{2}$ "FT	48	1	st.
1048591	20-Rp $\frac{1}{2}$ "FT	30	1	st.
1048592	20-Rp $\frac{3}{4}$ "FT	20	1	st.
1048593	25-Rp $\frac{3}{4}$ "FT	20	1	st.
1048594	25-Rp1"FT	20	1	st.

Uponor RTM koppeling verlopend				
 1048573	25-16	20	1	st.

Uponor RTM T-stuk verlopend				
 1059011	16-20-16	20	1	st.

Uponor RTM T-stuk binnendraad				
 1048587	16-Rp $\frac{1}{2}$ "FT-16	30	1	st.
1048588	20-Rp $\frac{1}{2}$ "FT-20	20	1	st.
1048589	20-Rp $\frac{3}{4}$ "FT-20	20	1	st.

Uponor RTM schroefverbinding bi.dr.				
 1057375	16- $\frac{1}{2}$ "SN	24	1	st.
1057376	20- $\frac{3}{4}$ "SN	24	1	st.

Uponor RTM

art.nr.	omschrijving	LE	VPE	eenheid
---------	--------------	----	-----	---------

Uponor RTM adapter

 1048604	16-G $\frac{3}{4}$ "Euro	25	1	st.
1048605	20-G $\frac{3}{4}$ "Euro	25	1	st.

Uponor RTM koppeling overgang koper/RVS

 1048603	16-15CU	40	1	st.
1057377	25-22CU	20	1	st.

Uponor RTM eindstuk

 1059013	16	48	1	st.
--	----	----	---	-----

Uponor Smart Aqua U-muurplaat RTM

 1061621	16-Rp $\frac{1}{2}$ "FT-16	20	5	st.
---	----------------------------	----	---	-----

Uponor Smart Aqua muurplaat RTM

 1048596	16-Rp $\frac{1}{2}$ "FT	20	1	st.
1048597	20-Rp $\frac{1}{2}$ "FT	20	1	st.
1048598	20-Rp $\frac{3}{4}$ "FT	20	1	st.

Uponor Smart Aqua SK-knie 90° RTM Geberit

 1057380	16-G $\frac{1}{2}$ "FT	35	1	st.
--	------------------------	----	---	-----

art.nr.	omschrijving	LE	VPE	eenheid
---------	--------------	----	-----	---------

Uponor S-Press PLUS montageplaat

 NEW 1121197	80/150mm	5	1	st.
---	----------	---	---	-----

Uponor S-Press PLUS montagebeugel

 NEW 1121196	100mm	5	1	st.
NEW 1121195	80/150mm	5	1	st.





Uponor Smart Aqua montagebeugel Gemini

 1059824	120mm	5	1	st.
1059825	150mm	5	1	st.





Uponor Smart Radi aansluitknie RTM

 1057379	16-15CU l=200mm	15	1	st.
---	-----------------	----	---	-----

Uponor Uni-X

art.nr.	omschrijving	LE	VPE	een- heid
Uponor Uni-X schroefkoppeling MLC				
 1058089	14-3/4"FT Euro	25	1	st.
 1058090	16-3/4"FT Euro	25	1	st.
 1058092	20-3/4"FT Euro	25	1	st.
 1058093	25-3/4"FT Euro	25	1	st.

art.nr.	omschrijving	LE	VPE	een- heid
Uponor Uni-X schroefkoppeling MLC				
 1058091	18-3/4"FT Euro	25	1	st.





art.nr.	omschrijving	LE	VPE	een- heid
Uponor Uni-X renovatie overgang MLC				
 1048745	16x2,0-16x2,0	10	1	set
 1048746	16x2,0-16x2,25	10	1	set
 1048747	20x2,25-20x2,25	10	1	set
 1048748	20x2,25-20x2,5	10	1	set

art.nr.	omschrijving	LE	VPE	een- heid
Uponor Uni-X schroefkoppeling MLC				
 1058094	16-M22	25	1	st.

art.nr.	omschrijving	LE	VPE	een- heid
Uponor Uni-X schroefkoppeling MLC				
 1058095	16-M24	25	1	st.

art.nr.	omschrijving	LE	VPE	een- heid
Uponor Uni-X schroefkoppeling MLC Begemac				
 1058096	16-M24	25	1	st.

art.nr.	omschrijving	LE	VPE	een- heid
Uponor Uni-X overgangstuk				
 1014143	3/4"MT-3/4"FT Euro	80	10	st.

art.nr.	omschrijving	LE	VPE	een- heid
Uponor Uni-X schroefkoppeling MLC NL				
 1048100	14-15mm	25	1	st.
 1048101	16-15mm	25	1	st.
 1089724	20-15mm	25	1	st.
 1048103	20-22mm	25	1	st.
 1048104	25-22mm	25	1	st.

art.nr.	omschrijving	LE	VPE	een- heid
Uponor Uni-X S-press adapter Euroconus				
 1087281	20-G3/4"FT Euro	60	15	st.

art.nr.	omschrijving	LE	VPE	een- heid
Uponor Uni-X dubbele nippel Euroconus				
 1006641	G3/4"MT Euro-G3/4"MT Euro	80	20	st.

art.nr.	omschrijving	LE	VPE	een- heid
Uponor Uni-X knie 90° buitendraad				
 1014145	3/4"MT-3/4"MT Euro	80	10	st.

art.nr.	omschrijving	LE	VPE	een- heid
Uponor Uni-X T-stuk buitendraad				
 1014147	3/4"MT-3/4"MT-3/4"MT	40	10	st.

Uponor GAS MLC

art.nr.	omschrijving	LE	VPE	eenheid
---------	--------------	----	-----	---------

Uponor GAS SAC leiding geel op rol

 1096433	20x2,25 100m	1300	100	m
1096434	25x2,5 50m	700	50	m
1096435	32x3,0 50m	400	50	m

Uponor GAS SAC leiding geel S

 1096436	20x2,25 5m	4335	85	m
1096437	25x2,5 5m	2550	50	m
1096438	32x3,0 5m	1530	30	m

Uponor GAS SAC leiding geel in mantelbuis

 1096439	20x2,25 75m	750	75	m
1096440	25x2,5 50m	500	50	m
1096441	32x3,0 50m	300	50	m

Uponor GAS mantelbuis

 1001390	28/23 yellow 50m	2000	50	m
1001400	34/29 yellow 50m	1400	50	m
1001401	42/36 yellow 50m	600	50	m
1045551	50/40 yellow 25m	500	25	m

Uponor GAS Press puntstuk

 1030552	20-R $\frac{1}{2}$ "MT	10	1	st.
1030553	20-R $\frac{3}{4}$ "MT	10	1	st.
1030554	25-R $\frac{3}{4}$ "MT	10	1	st.
1047241	25-R1"MT	10	1	st.
1030555	32-R1"MT	10	1	st.

Uponor GAS Press schroefbus

 1030556	20-Rp $\frac{1}{2}$ "FT	10	1	st.
1030557	20-Rp $\frac{3}{4}$ "FT	10	1	st.
1030558	25-Rp $\frac{3}{4}$ "FT	10	1	st.
1030559	25-Rp1"FT	10	1	st.
1042419	32-Rp1"FT	10	1	st.
1030560	32-Rp1 $\frac{1}{4}$ "FT	10	1	st.

Uponor GAS Press knie 90°

 1030561	20-20	10	1	st.
1030562	25-25	10	1	st.
1030563	32-32	10	1	st.

Uponor GAS Press T-stuk binnendraad

 1030564	20-Rp $\frac{1}{2}$ "FT-20	10	1	st.
1030565	25-Rp $\frac{1}{2}$ "FT-25	10	1	st.
1042538	20-Rp $\frac{3}{4}$ "FT-20	10	1	st.
1042539	25-Rp $\frac{3}{4}$ "FT-25	10	1	st.
1030566	32-Rp $\frac{3}{4}$ "FT-32	10	1	st.

art.nr.	omschrijving	LE	VPE	eenheid
---------	--------------	----	-----	---------

Uponor GAS Press T-stuk

 1083617	20-20-20	10	1	st.
1030567	25-25-25	10	1	st.
1030568	32-32-32	10	1	st.

Uponor GAS Press T-stuk verlopend

 1030569	25-20-20	10	1	st.
1030570	25-20-25	10	1	st.
1030571	32-25-32	10	1	st.
1030572	32-25-25	10	1	st.

Uponor GAS Press koppeling

 1030573	20-20	10	1	st.
1030574	25-25	10	1	st.
1030575	32-32	10	1	st.

Uponor GAS Press koppeling verlopend

 1030576	25-20	10	1	st.
1042540	32-25	10	1	st.

Uponor GAS Press muurplaat

 1030577	20-Rp $\frac{1}{2}$ "FT	10	1	st.
1083615	25-Rp $\frac{3}{4}$ "FT	5	1	st.

Uponor GAS veiligheidsverdeler inclusief gasstromingsbeveiliging

 1086826	Rp $\frac{3}{4}$ "FT 2XRp $\frac{3}{4}$ "FT c/ c50mm	12	1	st.
1086827	Rp $\frac{3}{4}$ "FT 3XRp $\frac{3}{4}$ "FT c/ c50mm	6	1	st.

Uponor GAS gasstromingsbeveiliging type K

 1086164	R $\frac{1}{2}$ "MT-RP $\frac{1}{2}$ "FT GS15HH2,5AIZ65	10	1	st.
1086162	R $\frac{3}{4}$ "MT-RP $\frac{3}{4}$ "FT GS20HH2,5AIZ165	10	1	st.
1083624	R $\frac{3}{4}$ "MT-Rp $\frac{3}{4}$ "FT GS20HH4AIZ165	10	1	st.
1086163	R1"MT-RP1"FT GS25HH2,5AIZ165	10	1	st.
1086161	R1"MT-RP1"FT GS25HH4AIZ165	10	1	st.
1083628	R1"MT-Rp1"FT GS25HH6AIZ165	10	1	st.

Uponor RS

Verdeel- en stijgleidingen 63-110 mm



RS 2 Adapter	RS 2 Basiscomponent	RS 3 Basiscomponent	RS 3 Adapter
40, 50, 63, 75 1½", 2", 2½" ½", 1", 2", 2½" 16, 20, 25, 32 DN 65 (PN 6/PN 16) 130 mm 5 mm	 RS 2 / RS 3	 	90, 110 3" ½", 3" DN 80 (PN 6/PN 16) DN 100 (PN 6/PN 16) 210 mm 5 mm

Uponor RS

art.nr.	omschrijving	LE	VPE	eenheid
---------	--------------	----	-----	---------

Uponor RS koppeling

	1029144 RS2-RS2	480	1	st.
	1029145 RS3-RS3	480	1	st.

Uponor RS knie 90°

	1029138 RS2-RS2	336	1	st.
	1029139 RS3-RS3	240	1	st.

Uponor RS knie 45°

	1029140 RS2-RS2	336	1	st.
	1029141 RS3-RS3	175	1	st.

Uponor RS T-stuk

	1029142 RS2-RS2-RS2	336	1	st.
	1029143 RS3-RS3-RS3	175	1	st.

Uponor RS koppeling verlopend

	1029146 RS3-RS2	480	1	st.
---	------------------------	-----	---	-----

Uponor RS verlengstuk

	1046750 RS2-RS2 l=5mm	480	1	st.
	1046751 RS3-RS3 l=5mm	240	1	st.

Uponor RS verlengstuk

	1046477 RS2-RS2 l=130mm	240	1	st.
	1046478 RS3-RS3 l=210mm	96	1	st.

art.nr.	omschrijving	LE	VPE	eenheid
---------	--------------	----	-----	---------

Uponor RS adapter S-Press

	1059397 16-RS2	480	1	st.
---	-----------------------	-----	---	-----

Uponor RS S-Press PLUS

	1095818 20-RS2	378	1	st.
	1095819 25-RS2	378	1	st.
	1095820 32-RS2	378	1	st.

Uponor RS adapter S-Press

	1046940 40-RS2	480	1	st.
	1046941 50-RS2	480	1	st.
	1029125 63-RS2	400	1	st.
	1029126 75-RS2	400	1	st.
	1029127 90-RS3	240	1	st.
	1029128 110-RS3	240	1	st.

Uponor RS adapter puntstuk

	1059402 R1 ½"MT-RS2	480	1	st.
	1029131 R2"MT-RS2	480	1	st.
	1029132 R2 ½"MT-RS2	480	1	st.
	1029133 R3"MT-RS3	240	1	st.

Uponor RS adapter schroefbus

	1059403 Rp½"FT-RS2	480	1	st.
	1029134 Rp1"FT-RS2	480	1	st.
	1029135 Rp2"FT-RS2	480	1	st.
	1029136 Rp2 ½"FT-RS2	480	1	st.
	1059404 Rp½"FT-RS3	336	1	st.
	1029137 Rp3"FT-RS3	240	1	st.

Uponor RS flens

	1059398 RS2-DN65 (PN6)	144	1	st.
	1059399 RS2-DN65 (PN16)	90	1	st.
	1059400 RS3-DN80 (PN6)	90	1	st.
	1029129 RS3-DN80 (PN16)	90	1	st.
	1059401 RS3-DN100 (PN6)	90	1	st.
	1029130 RS3-DN100 (PN16)	90	1	st.

Uponor RS vergrendelingselement zwart

	1042921 RS2 black	5000	10	st.
	1042922 RS3 grey	-	10	st.

Uponor PE-Xa installatiesystemen

art.nr.	omschrijving	LE	VPE	eenheid
---------	--------------	----	-----	---------

Uponor Aqua Pipe

Uponor Aqua Pipe naturel PN10

 1022682	16x2,2	1100	100	m
1001201	20x2,8	550	50	m
1001202	25x3,5	400	50	m
1001203	32x4,4	350	50	m

Uponor Aqua Pipe naturel PN10 S

 1008407	20x2,8 6m	240	30	m
1008424	25x3,5 6m	12	6	m
1001206	32x4,4 6m	1080	12	m

Uponor Aqua Pipe naturel in mantelbuis black

 1008993	16x2,2 25/20	550	50	m
1008994	20x2,8 28/23	400	50	m
1008995	25x3,5 34/28	300	50	m

Uponor Radi Pipe

Uponor Radi Pipe naturel PN6

 1047610	16x2,0	960	120	m
1022518	20x2,0	840	120	m
1022689	25x2,3	450	50	m
1001220	32x2,9	550	50	m

Uponor Radi Pipe naturel PN6 S

 1001221	25x2,3 6m	12	6	m
1001222	32x2,9 6m	12	6	m

Uponor Radi Pipe naturel in mantelbuis PN6 red

 1008388	16x2,0 25/20	550	50	m
1042149	20x2,0 28/23	400	50	m

Uponor Radi Pipe naturel in mantelbuis PN6 black

 1072092	25x2,3 34/28	300	50	m
--	--------------	-----	----	---

Uponor Combi Pipe

Uponor Combi Pipe naturel PN10

 1060081	12x1,7	840	60	m
--	--------	-----	----	---

art.nr.	omschrijving	LE	VPE	eenheid
---------	--------------	----	-----	---------

Uponor Teck

Uponor Teck mantelbuis rood red

 1012858	25/20	2500	50	m
1012862	28/23	2000	50	m
1012866	35/29	1400	50	m

Uponor Teck mantelbuis blauw blue

 1012859	25/20	2500	50	m
1012863	28/23	2000	50	m
1012867	35/29	1400	50	m

Uponor Teck mantelbuis zwart black

 1012860	25/20	2500	50	m
1012864	28/23	2000	50	m
1012869	35/29	1400	50	m
1012872	43/36	600	25	m

Uponor Flex

Uponor Multi leiding geleidebocht kunststof

 1000118	18	250	50	st.
1001229	20	2300	50	st.
1001230	28	900	50	st.

Uponor Multi leiding geleidebocht staal

 1001231	34	1400	2	st.
--	----	------	---	-----

Uponor Teck plughaken enkel

 1013137	32 60mm	1000	50	st.
1013138	32 80mm	1000	50	st.

Uponor Teck plughaken dubbel

 1013139	32 60mm	1000	50	st.
1013140	32 80mm	1000	50	st.

Uponor Smart Radi dubbelrozet, wit

 1011373	14-20 white double	500	50	st.
--	--------------------	-----	----	-----

Uponor PE-Xa installatiesystemen

art.nr.	omschrijving	LE	VPE	een- heid
Uponor Q&E zekeringsring white				
 1057453	16	900	20	st.
1057454	20	520	20	st.
1057455	25	300	20	st.
1057456	32	150	10	st.

Uponor Q&E zekeringsring red				
 1058010	16	900	20	st.
1058011	20	520	20	st.
1058012	25	300	20	st.

Uponor Q&E zekeringsring blue				
 1058013	16	900	20	st.
1058014	20	520	20	st.
1058015	25	300	20	st.

Uponor Q&E ring met stop edge red				
 1058454	12	1200	20	st.

Uponor Q&E ring met stop edge blue				
 1058453	12	1200	20	st.

Uponor Q&E verdeler PPSU				
 1008718	25, 3X16 c/c45+35	15	1	st.
1008719	25 4X16 c/c45+2X35	15	1	st.

Uponor Q&E knie 90° PPSU				
 1008679	16-16	100	5	st.
1008680	20-20	40	5	st.
1008681	25-25	25	5	st.
1001245	32-32	10	1	st.

art.nr.	omschrijving	LE	VPE	een- heid
Uponor Q&E koppeling PPSU				
 1008669	16-16	100	5	st.
1008932	20-20	80	5	st.
1008671	25-25	50	5	st.
1001235	32-32	15	1	st.

Uponor Q&E koppeling verlopend PPSU				
 1008674	20-16	100	5	st.
1008675	25-16	40	5	st.
1008676	25-20	40	5	st.
1001240	32-25	20	1	st.

Uponor Q&E T-stuk PPSU				
 1008684	16-16-16	60	5	st.
1008685	20-20-20	30	5	st.
1008686	25-25-25	20	5	st.
1001250	32-32-32	10	1	st.

Uponor Q&E T-stuk verlopend PPSU				
 1008700	20-16-16	40	5	st.
1008689	20-16-20	40	5	st.
1008697	20-20-16	40	5	st.
1008711	20-25-20	25	5	st.
1008702	25-16-16	25	5	st.
1008699	25-16-20	25	5	st.
1008690	25-16-25	25	5	st.
1008701	25-20-16	25	5	st.
1008703	25-20-20	25	5	st.
1008691	25-20-25	20	5	st.
1001420	25-25-20	20	5	st.
1008712	25-32-25	15	1	st.
1001422	32-20-25	15	1	st.
1001424	32-20-32	15	1	st.
1008704	32-25-20	15	1	st.
1001426	32-25-25	15	1	st.
1001428	32-25-32	15	1	st.

Uponor Q&E puntstuk PL				
 1023003	16-R½"MT	100	5	st.
1023004	16-R¾"MT	80	5	st.
1023005	20-R½"MT	100	5	st.
1023006	20-R¾"MT	70	5	st.
1023007	25-R¾"MT	70	5	st.
1023008	25-R1"MT	40	5	st.
1047191	32-R1"MT	10	1	st.

Uponor PE-Xa installatiesystemen

art.nr.	omschrijving	LE	VPE	eenheid
---------	--------------	----	-----	---------

Uponor Q&E puntstuk PL

 1058462	12-G $\frac{1}{2}$ "MT	100	10	st.
--	------------------------	-----	----	-----

Uponor Q&E schroefbus PL

 1058464	12-Rp $\frac{1}{2}$ "FT	100	10	st.
1023009	16-Rp $\frac{1}{2}$ "FT	60	5	st.
1023010	20-Rp $\frac{1}{2}$ "FT	60	5	st.
1023011	20-Rp $\frac{3}{4}$ "FT	40	5	st.
1023012	25-Rp $\frac{3}{4}$ "FT	40	5	st.
1023013	25-Rp1"FT	35	5	st.

Uponor Q&E schroefbus PL

 1047866	32-G1"FT	20	1	st.
--	----------	----	---	-----

Uponor Q&E knie 90° PL

 1058470	12-12	200	10	st.
1047197	16-16	80	5	st.
1047198	20-20	40	5	st.
1047199	25-25	25	5	st.

Uponor Q&E knie buitendraad PL

 1058471	12-G $\frac{3}{8}$ "MT	100	10	st.
1058472	12-G $\frac{1}{2}$ "MT	120	10	st.
1023019	16-G $\frac{3}{8}$ "MT	80	5	st.
1023020	20-G $\frac{3}{8}$ "MT	50	5	st.
1023021	20-G $\frac{1}{4}$ "MT	40	5	st.
1023022	25-G $\frac{3}{8}$ "MT	40	5	st.

Uponor Q&E knie binnendraad PL

 1023023	16-G $\frac{1}{2}$ "FT	70	5	st.
1023024	20-G $\frac{1}{2}$ "FT	50	5	st.
1023025	20-G $\frac{3}{4}$ "FT	30	5	st.
1023026	25-G $\frac{3}{4}$ "FT	35	5	st.

Uponor Q&E koppeling PL

 1058467	12-12	250	10	st.
1047193	16-16	100	10	st.
1047194	20-20	80	5	st.
1047195	25-25	50	5	st.

art.nr.	omschrijving	LE	VPE	eenheid
---------	--------------	----	-----	---------

Uponor Q&E koppeling verlopend PL

 1058468	16-12	200	10	st.
1047875	32-25	2880	30	st.



Uponor Q&E T-stuk PL

 1058475	12-12-12	150	10	st.
--	----------	-----	----	-----

Uponor Q&E T-stuk verlopend PL

 1058477	16-12-12	120	10	st.
1058478	16-12-16	100	10	st.
1058479	16-16-12	100	10	st.

Uponor Q&E T-stuk binnendraad PL

 1047885	16-Rp $\frac{1}{2}$ "FT-16	50	5	st.
1047886	20-Rp $\frac{1}{2}$ "FT-20	30	5	st.
1047887	25-Rp $\frac{1}{2}$ "FT-25	25	5	st.
1047888	25-Rp $\frac{3}{4}$ "FT-25	20	5	st.
 1047201	32-Rp1"FT-32	10	1	st.

OUT Artikel is uitlopend.
Levering zolang de voorraad strekt.

Uponor Q&E schroefkoppeling vlakd. PL

 1058466	12-G $\frac{1}{2}$ "SN	100	10	st.
1023014	16-G $\frac{1}{2}$ "SN	100	5	st.
1023015	20-G $\frac{1}{2}$ "SN	60	5	st.
1023016	20-G $\frac{3}{4}$ "SN	50	5	st.
1023017	25-G $\frac{3}{4}$ "SN	45	5	st.
1023018	25-G1"SN	40	5	st.

Uponor Q&E schroefverbindingsknie bi. PL

 1058473	12-G $\frac{3}{8}$ "SN	100	10	st.
--	------------------------	-----	----	-----

Uponor Q&E overgang DR S-Press

 1062845	16-Q&E16	20	1	st.
1062846	20-Q&E20	10	1	st.
1062861	25-Q&E25	10	1	st.

Uponor PE-Xa installatiesystemen

art.nr.	omschrijving	LE	VPE	eenheid
Uponor Q&E overgangskoppeling soldeer PL				
 1085248	12-15CU	100	5	st.
1047938	16-12CU	100	5	st.
1023040	16-15CU	100	5	st.
1023041	20-15CU	100	5	st.
1047940	20-18CU	80	5	st.
1047941	20-22CU	80	5	st.
1023042	25-22CU	40	5	st.

art.nr.	omschrijving	LE	VPE	eenheid
Uponor Smart Aqua U-muurplaat Q&E				
 1059820	16-Rp½"FT-16	5	1	st.
1059821	20-Rp½"FT-20	5	1	st.

art.nr.	omschrijving	LE	VPE	eenheid
Uponor Smart Aqua muurplaat Q&E PL				
 1095355	12-Rp½"FT	40	5	st.
1059822	16-Rp½"FT	40	5	st.
1059823	20-Rp½"FT	40	5	st.

art.nr.	omschrijving	LE	VPE	eenheid
Uponor S-Press PLUS montageplaat				
 NEW 1121197	80/150mm	5	1	st.

art.nr.	omschrijving	LE	VPE	eenheid
Uponor S-Press PLUS montagebeugel				
 NEW 1121196	100mm	5	1	st.
NEW 1121195	80/150mm	5	1	st.

art.nr.	omschrijving	LE	VPE	eenheid
Uponor Smart Aqua montagebeugel Gemini				
 1059824	120mm	5	1	st.
1059825	150mm	5	1	st.

art.nr.	omschrijving	LE	VPE	eenheid
Uponor Smart Aqua enkele montagebeugel				
 1057843		5	1	st.

art.nr.	omschrijving	LE	VPE	eenheid
Uponor Smart Aqua montagerail				
 1057844	2m	10	1	st.

art.nr.	omschrijving	LE	VPE	eenheid
Uponor Smart Aqua buigtang voor montageplaat				
 1015424	2m	100	1	st.

art.nr.	omschrijving	LE	VPE	eenheid
Uponor Smart Aqua muurplaat Q&E PL				
 1023034	16-Rp½"FT l=43mm	40	5	st.
1023035	20-Rp½"FT l=43mm	40	5	st.

art.nr.	omschrijving	LE	VPE	eenheid
Uponor Smart Aqua montage-unit haaks Q&E Gemini PL				
 1023037	16-Rp½"FT c/c153mm	25	1	st.

art.nr.	omschrijving	LE	VPE	eenheid
Uponor Smart Radi radiat aansluitknie Q&E				
 1023045	16-15CU l=300mm	40	2	st.
1023047	16-15CU l=1100mm	20	2	st.
1023046	20-15CU l=300mm	30	2	st.

art.nr.	omschrijving	LE	VPE	eenheid
Uponor Smart Radi radiat aansl.-T-stuk Q&E				
 1023049	16-15CU-16 l=300mm	30	2	st.
1023050	20-15CU-20 l=300mm	30	2	st.

art.nr.	omschrijving	LE	VPE	eenheid
Uponor Smart Radi inbouwdoos voor radiat aansluitknie				
 1001366	c/c40-45-50mm	10	1	set

art.nr.	omschrijving	LE	VPE	eenheid
Uponor Q&E verdeler bi./bu. PL				
 1023027	¼"MT/FT 2X16 c/c35mm	20	1	st.
1023028	¼"MT/FT 3X16 c/c35mm	15	1	st.
1023029	¼"MT/FT 4X16 c/c35mm	10	1	st.

art.nr.	omschrijving	LE	VPE	eenheid
Uponor Flex-X schroefkoppeling Euroconus PEX				
 1057441	16x1,8/2,0-¾"FT Euro	100	10	st.
1057442	20x1,9/2,0-¾"FT Euro	100	10	st.

art.nr.	omschrijving	LE	VPE	eenheid
Uponor Smart Radi klemkoppeling elastisch				
 1013830	15CU-¾" Euro	80	10	st.

art.nr.	omschrijving	LE	VPE	eenheid
Uponor Smart Radi radiat aansluitnippel				
 1013906	G¼"MT-G½"MT	80	10	st.

NEW Uponor PE-Xa Aqua PLUS verdeler PPM

art.nr.	omschrijving	LE	VPE	eenheid
 1087121	3X c/c50mm	8	1	st. M7
1087122	2X c/c50mm	10	1	st. M7
1087123	1X c/c50mm	20	1	st. M7

Uponor Aqua PLUS verdeler 1+1 PPM

 1087124	1+1X c/c50mm	15	1	st. M7
---	--------------	----	---	--------

Uponor Aqua PLUS afsluitventiel PPM blauw

 1096407		50	1	st. M7
---	--	----	---	--------

Uponor Aqua PLUS afsluitventiel PPM rood

 1096408		50	1	st. M7
---	--	----	---	--------

Uponor Aqua PLUS Q&E aansluiting PPSU PPM

 1087111	12	30	1	st. M7
1087112	16	30	1	st. M7
1087113	20	30	1	st. M7

Uponor S-Press aansluiting Aqua PLUS PPM

 1087117	20	30	1	st. M7
---	----	----	---	--------

Uponor S-Press PLUS aansluiting PPSU

 1119005	16	30	1	st.
---	----	----	---	-----

Uponor Aqua PLUS aansluiting PL/DR PPM FPL

 1087118	G1/2"MT	30	1	st. M7
---	---------	----	---	--------

Uponor Aqua PLUS plug PPSU PPM

 1087110		30	1	st. M7
---	--	----	---	--------

Uponor Aqua PLUS moersleutel PPM

 1092669		1000	1	st. M7
---	--	------	---	--------

Uponor Aqua PLUS MT overgang buitendraad PPM

 1048002	1" G3/4"MT	20	1	st. M7
---	------------	----	---	--------

art.nr.	omschrijving	LE	VPE	eenheid
 1063785	1"MT-G3/4"SN	20	1	st. M7

Uponor Aqua PLUS FT overgang binnendraad SN PPM

 1063811	1"FT-3/4"SN	25	1	st. M7
---	-------------	----	---	--------

Uponor Aqua PLUS MT overgangsknie buitendraad PPM

 1048003	1" G3/4"MT	20	1	st. M7
---	------------	----	---	--------

Uponor Aqua PLUS MT overgangsknie binnendraad PPM

 1063782	1"MT-1"FT	20	1	st. M7
---	-----------	----	---	--------

Uponor Aqua PLUS eindkap PPM

 1048004	1"FT	20	1	st. M7
---	------	----	---	--------

Uponor Aqua PLUS ontluchtingseindkap PPM

 1048005	1"FT	20	1	st. M7
--	------	----	---	--------

Uponor Aqua PLUS eindplug verdeler PPM

 1087119	MT	30	1	st. M7
---	----	----	---	--------

Uponor Aqua PLUS verdelerhouder PPM

 1092021		50	1	set M7
---	--	----	---	--------

Uponor Aqua PLUS PPM

 1087375		20	1	set M7
---	--	----	---	--------

Uponor Aqua PLUS isolatie verdeler EPP

 1087016	10x c/c50mm l=600	60	1	set M7
---	-------------------	----	---	--------

Uponor Aqua PLUS verdelerhouder verzinkt Q&E PPM

 1088844		25	1	st. M7
---	--	----	---	--------

Uponor Aqua PLUS kap isolatie verdeler EPP

 1087017	d=91mm	16	1	st. M7
---	--------	----	---	--------

Uponor Q&E GAS

art.nr.	omschrijving	LE	VPE	eenheid
---------	--------------	----	-----	---------

Uponor GAS evalPEX leiding geel

 1001383	16x2,2 100m	1100	100	m
1001385	20x2,8 50m	500	50	m
1001386	25x3,5 50m	450	50	m

Uponor GAS evalPEX leiding geel in mantelbuis yellow

 1001382	16x2,2 25/20 50m	550	50	m
1001384	20x2,8 28/23 50m	350	50	m

Uponor GAS mantelbuis

 1001390	28/23 yellow 50m	2000	50	m
1001400	34/29 yellow 50m	1400	50	m
1001401	42/36 yellow 50m	600	50	m

Uponor Q&E puntstuk PL

 1023003	16-R $\frac{1}{2}$ "MT	100	5	st.
1023005	20-R $\frac{1}{2}$ "MT	100	5	st.
1023006	20-R $\frac{3}{4}$ "MT	70	5	st.
1023007	25-R $\frac{3}{4}$ "MT	70	5	st.

Uponor Q&E koppeling PL

 1047193	16-16	100	10	st.
1047194	20-20	80	5	st.
1047195	25-25	50	5	st.

Uponor Q&E knie 90° PL

 1047197	16-16	80	5	st.
1047198	20-20	40	5	st.
1047199	25-25	25	5	st.

Uponor Q&E overgangskoppeling soldeer PL

 1023040	16-15CU	100	5	st.
1023041	20-15CU	100	5	st.
1023042	25-22CU	40	5	st.

Uponor Smart Aqua muurplaat Q&E PL

 1023034	16-Rp $\frac{1}{2}$ "FT l=43mm	40	5	st.
1023035	20-Rp $\frac{1}{2}$ "FT l=43mm	40	5	st.

art.nr.	omschrijving	LE	VPE	eenheid
---------	--------------	----	-----	---------

Uponor Q&E ring met stop-edge natural

 1044993	32	150	10	st.
--	----	-----	----	-----

Uponor Q&E Ring met stop-edge natural, eval

 1042389	16	900	20	st.
1042837	20	520	20	st.
1042841	25	300	20	st.

Uponor GAS veiligheidsverdeler inclusief gasstromingsbeveiliging

 1086826	Rp $\frac{3}{4}$ "FT 2XRp $\frac{3}{4}$ "FT c/ c50mm	12	1	st.
1086827	Rp $\frac{3}{4}$ "FT 3XRp $\frac{3}{4}$ "FT c/ c50mm	6	1	st.

Uponor GAS gasstromingsbeveiliging type K

 1086164	R $\frac{1}{2}$ "MT-RP $\frac{1}{2}$ "FT GS15HH2,5AIZ65	10	1	st.
1086162	R $\frac{3}{4}$ "MT-RP $\frac{3}{4}$ "FT GS20HH2,5AIZ165	10	1	st.
1083624	R $\frac{3}{4}$ "MT-Rp $\frac{3}{4}$ "FT GS20HH4AIZ165	10	1	st.
1086163	R1"MT-RP1"FT GS25HH2,5AIZ165	10	1	st.
1086161	R1"MT-RP1"FT GS25HH4AIZ165	10	1	st.
1083628	R1"MT-Rp1"FT GS25HH6AIZ165	10	1	st.

LET OP!

Het Uponor Q&E GAS leidingsysteem voor gasinstallaties mag niet in België en Luxemburg toegepast worden.

Uponor systemen om te verwarmen en te koelen

	Soort installatie	Systeemplaatdikte	Minimale opbouwhoogte* mm	Systeemnaam	Beschrijving	Bijbehorende systeemleidingen	Afmeting (mm)	
VLOER	NATBOUW	Noppenplaat-plaatsing, zelfklevend	—	15	Uponor Minitec	Zeer geringe opbouwhoogte, direct op de oude ondergrond (dekvloer, tegels, hout...)	Comfort Pipe	9,9
		Klittenband	DES 25-2, 30-2, 30-3, 35-3 WLS032 25-2, DEO 15	74	Uponor Klett	Microvertanding van systeemplaat en leiding. Snelste installatiemanier, geen beschadiging van de dekvloerfilm	Klett Comfort Pipe PLUS Klett MLCP RED	14, 16 16
		Klittenband op bestaande isolatieplaat	—	74	Uponor Klett Twinboard	Plaatsing met klittenband op bestaande isolatieplaat via montageplaten met holle kamer 3 mm	Klett Comfort Pipe PLUS Klett MLCP RED	14, 16 16
		Klittenband incl. isolatie in minerale wol	30	74	Uponor Klett Silent	Plaatsing met klittenband op platen in minerale wol, alternatieve uitschrijvingen	Klett Comfort Pipe PLUS Klett MLCP RED	14, 16 16
		In noppenfolie	—	30	Uponor Nubos	Vrije keuze van isolatiematerialen	Comfort Pipe PLUS MLCP RED	16 14, 16
	In noppenplaat	11 of 30-2	82	Uponor Tecto	Snelle montage van de leidingen, systeemplaten voor scheidingsplafonds van verdiepingen, stevige bevestiging	Comfort Pipe PLUS MLCP RED	14, 17 14, 16	
	In noppenplaat	11 of 30-2	78	Uponor Nubos	Gemakkelijk te gebruiken, normconforme plaatsingsafstanden	Comfort Pipe PLUS MLCP RED	16 14, 16	
	Op mattenwapening met clip	—	83	Uponor Classic	Hoogste geluidsisolatie (bestaande isolatie in minerale wol). Scheiding van verwarmingsniveau/dekvloer, grote verwarmingscircuits	Comfort Pipe PLUS Magna Pipe PLUS	17 20	
	Tacker en U-rails	EPS DEO 20, 26, 30 WLS040 50 DES 20-2, 25-2, 30-2, 30-3, 35-3, 40-3 WLS032 25-2	75	Uponor Tacker	Goedkoopste oplossing. Verschillende soorten thermische/contactgeluidisolatie verkrijgbaar	Comfort Pipe PLUS MLCP RED	16, 17 14, 16	
	DROOG	In voorgevormde EPS-platen en warmtegeleidingslamellen in aluminium	25	50	Uponor Siccus 14	Laag gewicht, onmiddellijk bruikbaar, hoge draagkracht	Comfort Pipe PLUS MLCP RED	14 14
Met geprefabriceerde kabelmatten, elektrische vloerverwarming		—	5	Uponor Comfort E Kabelmatten	Kabelmat met opgenaaide aluminiumfolie, zeer geringe opbouwhoogte, plaatsing op nagenoeg alle solide ondergronden, incl. regelmatig, snelle reactie	—		

	Soort installatie	Systeemplaatdikte	Minimale opbouwhoogte* mm	Systeemnaam	Beschrijving	Bijbehorende systeemleidingen	Afmeting (mm)	
WAND	NAT	Onder pleisterlaag, met spanrail	—	32	Uponor Fix	Efficiënte en torsievaste plaatsing van de leidingen vanaf de grote rol met minimaal snijafval	Comfort Pipe Comfort Pipe PLUS MLCP RED	9,9 14 14
	DROOG	In voorgevormde EPS-platen	25	30	Uponor Siccus Wall	Geen droogtijden en geen functieverwarming vereist	Comfort Pipe PLUS MLCP RED	14 14
		Voor verticale wanden, modulaire bouwwijze	—	32	Uponor Siccus SW	Dubbel gebruik door het gebruik van verticale wanden als verwarmings-/koeloppervlakken	Comfort Pipe PLUS	14
		Op CD-profielen 60/27, gipspaneel met geïntegreerde verwarmingsleidingen	—	15	Uponor Renovis	Vezelversterkte gipsplaat 15 mm, montage op gedefinieerde droogbouw-onderconstructies	Comfort Pipe PLUS (geïntegreerd)	9,9
PLAFOND	NAT	Onder pleisterlaag, met spanrail	—	32	Uponor Fix	Efficiënte en torsievaste plaatsing van de leidingen vanaf de grote rol met minimaal snijafval	Comfort Pipe	9,9
	DROOG	Op CD-profielen 60/27, gipspaneel met geïntegreerde verwarmingsleidingen	—	15	Uponor Renovis	Hoog plaatsingsrendement op CD-profielen	Comfort Pipe (geïntegreerd)	9,9
		Standaard onderconstructies	—	15	Uponor Thermatop M	Voeg- en richtingloze plafondoppervlakken	Uni Pipe PLUS	16
ANDERE TOEPASSINGEN	HALLEN	INDUSTRIËLE OPPERVLAKTEVERWARMING						
		Op spanrail			Uponor Magna	Optimaal gebruik van de ruimte zonder storende installatiecomponenten	Magna Pipe PLUS	20, 25
		Op mattenwapening						
	TABS	BETONKERNACTIVERING						
		Geprefabriceerde module op mattenwapening (wapening)			Uponor Contec	Om in de betonkern in te brengen	Magna Pipe PLUS	20
		Dicht bij het oppervlak			Uponor Contec ON	Diagonaal vastgezet honingraatrooster met voorbereide leidingen voor inbouw in de betonkern dicht tegen het oppervlak	Comfort Pipe PLUS	14
	DROOG	SPORTVLOEREN						
		In sporthallen	30		Uponor Siccus Sport	Voor oppervlakelastische sportvloeren in sandwichbouw-methode	Comfort Pipe PLUS MLC wit	14 14
		In sporthallen			Uponor Sport	Voor inbouw tussen onderlagen van oppervlakelastische sportvloeren	Magna Pipe PLUS	25
	OPEN VLAKTEN	OPPERVLAKTEVERWARMING / GRASVELDEN						
Sneeuw- en ijsvrijhouden van open vlakten				Uponor Meltaway	Montage met spanrail, voor veilige toegangen, bijv. opritten en toegangswegen naar ziekenhuizen, garages, landingsplaatsen voor helikopters of vliegtuigen, enz.	Magna Pipe PLUS	20, 25	

Installatie









Verwarming en koeling

Warmte- en koudedistributie

Gereedschappen

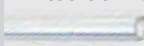
Bijlage

Uponor leidingen voor oppervlakteverwarming/-koeling

Type	Afmeting [mm]	Condensbarrière	Leidingkleur, Markering	Druk [bar]	Temperatuur [°C]	Lengte [m]	Artikelnr.	DIN-Certco Certificaat-nr.
Comfort Pipe PLUS 	14 x 2,0	PE-Xa + EVOH-isolatielaag	wit, 2 blauwe stroken	6	70	120 240 640 960	1062883 1062884 1088166 1062885	3V372
	16 x 2,0	PE-Xa + EVOH-isolatielaag	wit, 2 blauwe stroken	6	70	120 240 640	1062044 1062045 1062046	3V372
	17 x 2,0	PE-Xa + EVOH-isolatielaag	wit, 2 blauwe stroken	6	70	120 240 480 640	1034535 1009226 1086340 1009227	3V372
	20 x 2,0	PE-Xa + EVOH-isolatielaag	wit, 2 blauwe stroken	6	70	60	1009229	3V372
Uponor Comfort Pipe PN10 	16 x 2,2	PE-Xa + EVOH-isolatielaag	natuur	10	70	240 640	1119470 1119471	
	20 x 2,8	PE-Xa + EVOH-isolatielaag	natuur	10	70	240 640	1119472 1119533	
Klett Comfort Pipe PLUS 	14 x 2,0	PE-Xa + EVOH-isolatielaag	wit, 2 blauwe stroken, met klittenband	6	70	240 640	1088479 1088480	3V372
	16 x 2,0	PE-Xa + EVOH-isolatielaag	wit, 2 blauwe stroken, met klittenband	6	70	240 640	1087302 1087303	3V372
Magna Pipe PLUS 	20 x 2,0	PE-Xa + EVOH-isolatielaag	wit, 2 blauwe stroken	6	70	240 480	1091275 1091276	3V415
	25 x 2,3	PE-Xa + EVOH-isolatielaag	wit, 2 blauwe stroken	6	70	300 640	1091277 1091278	3V415
Minitec Comfort Pipe 	9,9 x 1,1	PE-Xa + EVOH-isolatielaag	natuur, 1 blauwe strook	6	70	60 120 480	1063287 1063288 1063381	3V279
MLC Rohr wit 	14 x 2,0	Composietleiding met AL	witte leiding	10	80	200	1013366	
MLCP RED 	14 x 1,6	Composietleiding met AL	rode leiding	4	60	240 480	1096010 1096011	3V286
	16 x 2,0	Composietleiding met AL	rode leiding	4	60	240 480	1096012 1096013	3V286
MLCP RED Klett 	16 x 2,0	Composietleiding met AL	witte leiding, 2 rode stroken, met klittenband	4	60	240 480	1096014 1096015	3V286

Verbindingstechniek, fittingen en gereedschap

(Klemring-) schroefkoppelingen



Platte sleutel
courant



Quick & Easy-fittingen



Q&E expansie-
gereedschap



bijbehorende
Q&E ringen



Rapex persfittingen



Rapex
persbekken



Smart pers- koppelingen



Persbekken MLC UPP1 en KSP0



S-Press en S-Press- PLUS koppelingen



Vario/Fit 14x2,0	M12 & M18	natural eval	14	14	-
Vario/Fit 16x2,0	M12 & M18	natural eval	16	16	-
Vario/Fit 17x2,0	M12 & M18	natural eval & wit	17	-	-
Vario/Fit 20x1,9/2,0	M12 & M18	natural eval & wit	-	20	-
Flex-X 16x2,2	M12 & M18	wit	-	-	-
Flex-X 20x2,8	M12 & M18	wit	-	-	-
Vario/Fit 14x2,0	M12 & M18	natural eval	14	14	-
Vario/Fit 16x1,8/2,0	M12 & M18	natural eval & wit	16	16	-
Vario/Fit 20x1,9/2,0	M12 & M18	natural eval & wit	-	20	-
Vario/Fit 25x2,3	M12 & M18	natural eval & wit	25	-	-
Vario & Minitec 9,9 x 1,1	Hand, M12 & M18	Minitec PEX	-	-	-
Uni-X 14-3/4 Euro	-	-	-	-	14
Vario MLCP RED 14x1,6 Euro	-	-	-	-	14 MLCP RED koppeling
Uni-X 16-3/4 Euro	-	-	-	-	16
Uni-X 16-3/4 Euro	-	-	-	-	16

Installatie

Verwarming
en koeling

Warmte- en
koudedistributie

Gereedschappen

Bijlage

Uponor 10 bar UFH vloerverwarming

art.nr.	omschrijving	LE	VPE	eenheid
Uponor Comfort Pipe PN10				
 1119470	16x2,2 240m	1440	240	m
1119471	16x2,2 640m	1280	640	m
1119472	20x2,8 240m	960	240	m
1119533	20x2,8 480m	960	480	m

Uponor Flex-X schroefkoppeling Euroconus PEX

 1045542	16x2,2-3/4"FT Euro	100	10	set
1045543	20x2,8-3/4"FT Euro	100	10	set

Uponor Q&E koppeling PPSU

 1008669	16-16	100	5	st.
1008932	20-20	80	5	st.

Uponor Q&E zekeringsring white

 1057453	16	900	20	st.
1057454	20	520	20	st.

art.nr.	omschrijving	LE	VPE	eenheid
Uponor Q&E expansiereedschap met expansiekop M12				
 1057167	16/20/25 10bar	-	1	set

Uponor Q&E expansiekop M12/M18

 1057172	16x1,8/2,0/2,2	-	1	st.
1057174	20x2,8	-	1	st.

Uponor Minitec

art.nr.	omschrijving	LE	VPE	eenheid
---------	--------------	----	-----	---------

Uponor Minitec folie-element

	1005261 15,4m ² 9,9x1,1 1100x700x12mm	123,2	15,4	m ²
---	---	-------	------	----------------

Uponor Fix Klemmenstrook

	1005274 9,9mm c/c20mm 2,5m	25	2,5	m
---	-----------------------------------	----	-----	---

Uponor Minitec randisolatie

	1005267 20m 80x8mm	200	20	m
---	---------------------------	-----	----	---

Uponor Minitec dilatatievoegprofiel

	1085980 0,9m 40x10mm	600	10	st.
	1085981 1,3m 40x10mm	600	10	st.

Uponor Minitec leiding Comfort Pipe

	1063287 9,9x1,1 60m	840	60	m
	1063288 9,9x1,1 120m	1680	120	m
	1063381 9,9x1,1 480m	2880	480	m

Uponor Minitec leiding mantelbuisfolie

	1005269 9,9mm 300x2mm	3600	30	st.
---	------------------------------	------	----	-----

Uponor Vario Euroconus schroefkoppeling Minitec

	1005266 9,9x1,1-3/4" Euro	100	10	st.
---	----------------------------------	-----	----	-----

Uponor Minitec koppeling

	1005264 9,9x1,1	100	10	st.
---	------------------------	-----	----	-----

Uponor Minitec puntstuk

	1005265 9,9-R1/2" MT	100	10	st.
---	-----------------------------	-----	----	-----

Uponor Minitec ring

	1005263 9,9x1,1	1600	10	st.
---	------------------------	------	----	-----

art.nr.	omschrijving	LE	VPE	eenheid
---------	--------------	----	-----	---------

Uponor Minitec klemringschroefkoppeling

	NEW 1013426 9,9-3/4" Euro	120	12	st.
---	---	-----	----	-----

Uponor Fluvia schroef-Y-stuk

	1005675 2xG3/4-3/4" Euro	50	1	set
---	---------------------------------	----	---	-----

Uponor Fluvia T pompgroep Push-12 AC-G

	1095128	60	1	st.
---	----------------	----	---	-----

Uponor Vario vul- en aftapkraan

	1061802 3/4" - 3/4"	10	1	set
---	----------------------------	----	---	-----

Uponor Minitec aansluitbox inbouwuitvoering

	1005270 1X	30	1	st.
	1005271 2X	-	1	st.
	1005272 3X	-	1	st.

De begrenzing van de berekende temperatuur dient door een voorregeling zeker gesteld te worden.

Uponor Minitec afdekplaat

	1007251	-	1	st.
---	----------------	---	---	-----

Uponor Base ruimtethermostaat T-23

	1058422 230V RAL9010	160	1	st.
---	-----------------------------	-----	---	-----

Uponor Minitec expansiegereedschap

	1006247 9,9x1,1	11	1	set
---	------------------------	----	---	-----

Uponor Q&E expansiegereedschap met expansiekop M12

	1063112 6BAR 9,9/20	-	1	set
---	----------------------------	---	---	-----

Uponor Q&E RS expansiegereedschap met expansiekop M12

	NEW 1119375 6bar 9,9RS/20	-	1	set
---	---	---	---	-----

Installatie

Verwarming en koeling

Warmte- en koudedistributie

Gereedschappen

Bijlage

Uponor Tecto

art.nr.	omschrijving	LE	VPE	eenheid
---------	--------------	----	-----	---------

Uponor Tecto noppenplaat

 1005478	EPS DES 30-2mm 14-17mm 1450x850mm	53,76	8,96	m ²
1005477	EPS 11mm 14-17mm 1450x850mm	94,08	15,68	m ²

Uponor Tecto diagonale leidinghouder

 1005482	45 75mm	420	10	st.
--	---------	-----	----	-----

Uponor Tecto koppelstrook

 1005484	1,4m 100mm	742,5	33,75	m
--	------------	-------	-------	---

Uponor Tecto afdekfolie

 1005481	1,45m 200mm	504	28	m
--	-------------	-----	----	---

Uponor Tecto isolatiestrook

 1005480	EPS DES 30-2mm 150x1400mm	268,8	8,4	m
1005479	EPS 11mm 150x1400mm	716,8	22,4	m

Uponor Multi randisolatie met foliestrook

 1000079	150x8mm	-	200	m
--	---------	---	-----	---

Uponor Multi randisolatie met foliestrook

 1000080	150x10mm	-	200	m
--	----------	---	-----	---

Uponor Multi dilatatieprofiel

 1090229	1800x100x10mm	720	18	m
--	---------------	-----	----	---

Uponor Multi beschermingsmantel

 1000082	20mm 300x5mm	10800	30	st.
--	--------------	-------	----	-----

art.nr.	omschrijving	LE	VPE	eenheid
---------	--------------	----	-----	---------

Uponor Comfort Pipe PLUS leiding

 1062883	14x2,0 120m	1320	120	m
1062884	14x2,0 240m	1680	240	m
1088166	14x2,0 640m	1920	640	m
1062885	14x2,0 960m	1920	960	m
1062044	16x2,0 120m	1080	120	m
1062045	16x2,0 240m	1440	240	m
1062046	16x2,0 640m	1280	640	m
1034535	17x2,0 120m	840	120	m
1009226	17x2,0 240m	1200	240	m
1086340	17x2,0 480m	960	480	m
1009227	17x2,0 640m	1280	640	m

Uponor Vario klemringschroefkoppeling PEX

 1065283	14x2,0-G¾"FT Euro	25	1	st.
1065284	16x1,8/2,0-G¾"FT Euro	25	1	st.
1065286	17x2,0-G¾"FT Euro	25	1	st.

Uponor Fit Schroefkoppeling PEX

 1065296	16x1,8/2,0-16x1,8/2,0	25	1	st.
1065299	17x2,0-17x2,0	25	1	st.

Uponor Fit klemovergangspuntstuk PEX

 1065294	14x2,0-R½"MT	25	1	st.
1065297	16x1,8/2,0-R½"MT	25	1	st.
1065300	17x2,0-R½"MT	25	1	st.

Uponor Fit klemovergangsschroefbus PEX

 1065295	14x2,0-Rp½"FT	25	1	st.
1065298	16x1,8/2,0-Rp½"FT	25	1	st.

Uponor Rapex perskoppeling

 1005079	17-17	100	10	st.
--	-------	-----	----	-----

Voor het maken van de persverbinding de volgende Uponor persbekken toepassen (zie Uponor gereedschap):

Uponor persbek voor 17 x 2 mm PE-X artikelnummer 1006343

Uponor Q&E koppeling met ringen DR

 1058659	14-14	100	10	st.
1058660	16x1,8/2,0-16x1,8/2,0	100	10	st.
1058661	17-17	100	10	st.

Uponor Tecto

art.nr.	omschrijving	LE	VPE	een- heid
---------	--------------	----	-----	--------------

Uponor Q&E ring met stop-edge natural, eval

	1058428 14	900	20	st.
---	-------------------	-----	----	-----

Uponor Smart perskoppeling

	1089646 14x2,0-14x2,0	80	20	st.
	1089647 16x1,8/2,0-16x1,8/2,0	80	20	st.

Let op: pers met Uponor S-Press persbekken UPP1 voor Uponor MLC perskoppelingen of mini persbekken KSP0

art.nr.	omschrijving	LE	VPE	een- heid
---------	--------------	----	-----	--------------

Uponor MLCP RED leiding

	1096010 14x1,6 240m	3120	240	m
	1096011 14x1,6 480m	3360	480	m
	1096012 16x2,0 240m	3120	240	m
	1096013 16x2,0 480m	3360	480	m

Uponor Vario klemkoppeling MLCP RED

	1000117 14x1,6-¾" Euro	80	20	st.
---	-------------------------------	----	----	-----

Uponor MLCP RED perskoppeling

	1048272 14x1,6-14x1,6	80	20	st.
---	------------------------------	----	----	-----

Uponor S-Press PLUS koppeling

	1070547 16-16	80	20	st.
---	----------------------	----	----	-----

Uponor S-Press PLUS koppeling PPSU

	1039933 16-16	80	20	st.
---	----------------------	----	----	-----

Uponor Uni-X schroefkoppeling MLC

	1058090 16-¾" FT Euro	25	1	st.
---	------------------------------	----	---	-----



Uponor Multi leiding geleidebocht kunststof

	1000118 18	250	50	st.
---	-------------------	-----	----	-----

Uponor Nubos

art.nr.	omschrijving	LE	VPE	eenheid
Uponor Nubos noppenplaat				
 1016699	EPS 30-2 14-16mm 1447x900x48mm	60	10	m ²
1016700	EPS 11 14-16mm 1447x900x29mm	100	10	m ²

art.nr.	omschrijving	LE	VPE	eenheid
Uponor Nubos noppenfolie				
 1016703	14-16mm	140	10	m ²
1061880	14-16mm	-	200	m ²

art.nr.	omschrijving	LE	VPE	eenheid
Uponor Nubos noppenplaat verd./deurset				
 1016701	EPS 30-2 14-16mm 1447x900x48mm	50	5	m ²
 1016702	EPS 11 14-16mm 1447x900x29mm	50	5	m ²

art.nr.	omschrijving	LE	VPE	eenheid
Uponor Multi randisolatie met foliestrook				
 1000079	150x8mm	-	200	m

art.nr.	omschrijving	LE	VPE	eenheid
Uponor Multi randisolatie met foliestrook				
 1000080	150x10mm	-	200	m

art.nr.	omschrijving	LE	VPE	eenheid
Uponor Multi dilatatieprofiel				
 1090229	1800x100x10mm	720	18	m

art.nr.	omschrijving	LE	VPE	eenheid
Uponor Multi beschermingsmantel				
 1000082	20mm 300x5mm	10800	30	st.

art.nr.	omschrijving	LE	VPE	eenheid
Uponor Fix klemprofiel, zelfklevend				
 1000018	14-20mm c/c50mm 1m	600	100	m

art.nr.	omschrijving	LE	VPE	eenheid
Uponor Comfort Pipe PLUS leiding				
 1062883	14x2,0 120m	1320	120	m
1062884	14x2,0 240m	1680	240	m
1088166	14x2,0 640m	1920	640	m
1062885	14x2,0 960m	1920	960	m
1062044	16x2,0 120m	1080	120	m
1062045	16x2,0 240m	1440	240	m
1062046	16x2,0 640m	1280	640	m

art.nr.	omschrijving	LE	VPE	eenheid
Uponor Vario klemringschroefkoppeling PEX				
 1065283	14x2,0-G $\frac{3}{4}$ "FT Euro	25	1	st.
1065284	16x1,8/2,0-G $\frac{3}{4}$ "FT Euro	25	1	st.

art.nr.	omschrijving	LE	VPE	eenheid
Uponor Fit Schroefkoppeling PEX				
 1065296	16x1,8/2,0-16x1,8/2,0	25	1	st.

art.nr.	omschrijving	LE	VPE	eenheid
Uponor Fit klemovergangsschroefbus PEX				
 1065298	16x1,8/2,0-Rp $\frac{1}{2}$ "FT	25	1	st.

art.nr.	omschrijving	LE	VPE	eenheid
Uponor Q&E koppeling met ringen DR				
 1058660	16x1,8/2,0-16x1,8/2,0	100	10	st.

art.nr.	omschrijving	LE	VPE	eenheid
Uponor Smart perskoppeling				
 1089646	14x2,0-14x2,0	80	20	st.
1089647	16x1,8/2,0-16x1,8/2,0	80	20	st.

Let op: pers met Uponor S-Press persbekken UPP1 voor Uponor MLC perskoppelingen of mini persbekken KSP0

art.nr.	omschrijving	LE	VPE	eenheid
Uponor MLCP RED leiding				
 1096010	14x1,6 240m	3120	240	m
1096011	14x1,6 480m	3360	480	m
1096012	16x2,0 240m	3120	240	m
1096013	16x2,0 480m	3360	480	m

art.nr.	omschrijving	LE	VPE	eenheid
Uponor Vario klemkoppeling MLCP RED				
 1000117	14x1,6- $\frac{3}{4}$ "Euro	80	20	st.

art.nr.	omschrijving	LE	VPE	eenheid
Uponor MLCP RED perskoppeling				
 1048272	14x1,6-14x1,6	80	20	st.

art.nr.	omschrijving	LE	VPE	eenheid
Uponor Uni-X Schroefkoppeling MLC				
 1058090	16- $\frac{3}{4}$ "FT Euro	25	1	st.

art.nr.	omschrijving	LE	VPE	eenheid
Uponor Multi leiding geleidebocht kunststof				
 1000118	18	250	50	st.

Uponor Klett

art.nr.	omschrijving	LE	VPE	eenheid
Uponor Klett rol extra				
 1063402	EPS DES 25-2mm 10x1m	80	10	m ²
1063322	EPS DES 30-2mm 10x1m	80	10	m ²
1063323	EPS DES 30-3mm 10x1m	80	10	m ²
1063324	EPS DES 35-3mm 10x1m	70	10	m ²

Uponor Klett dubbele plaat				
 1086854	2400x1000x3mm	360	24	m ²

Uponor Multi randisolatie met foliestrook				
 1000079	150x8mm	-	200	m

Uponor Multi randisolatie met foliestrook				
 1000080	150x10mm	-	200	m

Uponor Multi dilatatieprofiel				
 1090229	1800x100x10mm	720	18	m

Uponor Multi beschermingsmantel				
 1000082	20mm 300x5mm	10800	30	st.

Uponor Klett plaat Silent				
 1088065	1200x1000x30mm	48	4,8	m ²

Uponor Klett randisolatie				
 1089919	1200X120X13mm	1536	96	m

Uponor Klett afdichtfolie				
 1089951	50m 280x0,2mm	6000	50	m

art.nr.	omschrijving	LE	VPE	eenheid
Uponor Klett leiding Comfort Pipe PLUS				
 1088479	14x2,0 240m	1440	240	m
1088480	14x2,0 640m	1280	640	m
1087302	16x2,0 240m	1200	240	m
1087303	16x2,0 640m	1280	640	m

Uponor Vario klemringschroefkoppeling PEX				
 1065283	14x2,0-G $\frac{3}{4}$ "FT Euro	25	1	st.
1065284	16x1,8/2,0-G $\frac{3}{4}$ "FT Euro	25	1	st.

Uponor Smart perskoppeling				
 1089646	14x2,0-14x2,0	80	20	st.
1089647	16x1,8/2,0-16x1,8/2,0	80	20	st.

Let op: pers met Uponor S-Press persbekken UPP1 voor Uponor MLC perskoppelingen of mini persbekken KSP0

Uponor Fit Schroefkoppeling PEX				
 1065296	16x1,8/2,0-16x1,8/2,0	25	1	st.

Uponor Fit klemovergangspuntstuk PEX				
 1065294	14x2,0-R $\frac{1}{2}$ "MT	25	1	st.
1065297	16x1,8/2,0-R $\frac{1}{2}$ "MT	25	1	st.

Uponor Fit klemovergangsschroefbus PEX				
 1065295	14x2,0-Rp $\frac{1}{2}$ "FT	25	1	st.
1065298	16x1,8/2,0-Rp $\frac{1}{2}$ "FT	25	1	st.

Uponor Q&E koppeling met ringen DR				
 1058659	14-14	100	10	st.
1058660	16x1,8/2,0-16x1,8/2,0	100	10	st.

Uponor Q&E ring met stop-edge natural, eval				
 1058428	14	900	20	st.

Uponor Q&E zekeringsring white				
 1057453	16	900	20	st.

Uponor Klett

art.nr.	omschrijving	LE	VPE	eenheid
 1096014	16X2,0 240M	1920	240	m
1096015	16X2,0 480M	2400	480	m

Uponor Uni-X schroefkoppeling MLC

 1058090	16-3/4"FT Euro	25	1	st.
--	----------------	----	---	-----

Uponor S-Press PLUS koppeling

 1070547	16-16	80	20	st.
--	-------	----	----	-----

Uponor S-Press PLUS koppeling PPSU

 1039933	16-16	80	20	st.
--	-------	----	----	-----

art.nr.	omschrijving	LE	VPE	eenheid
 1000012	66m 50mm	36	1	st.

Uponor Multi plakbandroller

 1000142		20	1	st.
--	--	----	---	-----

Uponor Multi leiding geleidebocht kunststof

 1000118	18	250	50	st.
--	----	-----	----	-----

Uponor Multi leidinggeleider

 1088066		-	1	st.
---	--	---	---	-----

 **OUT** Artikel is uitlopend.
Levering zolang de voorraad strekt.

Uponor Tacker

art.nr.	omschrijving	LE	VPE	een- heid
---------	--------------	----	-----	--------------

Uponor Tacker rol

 1090921	EPS DES 20-2mm 10x1m	100	10	m ²
1090924	EPS DES 30-2mm 10x1m	80	10	m ²
1090925	EPS DES 30-3mm 10x1m	80	10	m ²
1090926	EPS DES 35-3mm 10x1m	70	10	m ²
1090927	EPS DES 40-3mm 10x1m	60	10	m ²

Uponor Tacker plaat

 1090917	EPS DEO 20	100	10	m ²
1090918	EPS DEO 30	80	10	m ²

Uponor Tacker Folie transparant

 NEW 1122372	0,2mm 100x1,03m	2884	103	m ²
---	--------------------	------	-----	----------------

Uponor Multi randisolatie met foliestrook

 1000079	150x8mm	-	200	m
---	---------	---	-----	---

Uponor Multi randisolatie met foliestrook

 1000080	150x10mm	-	200	m
--	----------	---	-----	---

Uponor Multi dilatatieprofiel

 1090229	1800x100x10mm	720	18	m
--	---------------	-----	----	---

Uponor Multi beschermingsmantel

 1000082	20mm 300x5mm	10800	30	st.
--	--------------	-------	----	-----

Uponor Multi plakbandroller

 1000142		20	1	st.
--	--	----	---	-----

art.nr.	omschrijving	LE	VPE	een- heid
---------	--------------	----	-----	--------------

Uponor Comfort Pipe PLUS leiding

 1062883	14x2,0 120m	1320	120	m
1062884	14x2,0 240m	1680	240	m
1062885	14x2,0 960m	1920	960	m
1062044	16x2,0 120m	1080	120	m
1062045	16x2,0 240m	1440	240	m
1062046	16x2,0 640m	1280	640	m
1034535	17x2,0 120m	840	120	m
1009226	17x2,0 240m	1200	240	m
1009227	17x2,0 640m	1280	640	m

Uponor Magna pipe PLUS

 1091275	20x2,0 240m	960	240	m
1091276	20x2,0 480m	960	480	m

Uponor Vario klemringschroefkoppeling PEX

 1065283	14x2,0-G ³ / ₄ "FT Euro	25	1	st.
1065284	16x1,8/2,0-G ³ / ₄ "FT Euro	25	1	st.
1065286	17x2,0-G ³ / ₄ "FT Euro	25	1	st.
1065290	20x1,9/2,0-G ³ / ₄ "FT Euro	25	1	st.

Uponor Fit schroefkoppeling PEX

 1065296	16x1,8/2,0-16x1,8/2,0	25	1	st.
1065299	17x2,0-17x2,0	25	1	st.
1065302	20x1,9/2,0-20x1,9/2,0	25	1	st.

Uponor Smart perskoppeling

 1089646	14x2,0-14x2,0	80	20	st.
1089647	16x1,8/2,0-16x1,8/2,0	80	20	st.

Let op: pers met Uponor S-Press persbekken UPP1 voor Uponor MLC perskoppelingen of mini persbekken KSP0

Uponor Fit klemovergangspuntstuk PEX

 1065294	14x2,0-R ¹ / ₂ "MT	25	1	st.
1065297	16x1,8/2,0-R ¹ / ₂ "MT	25	1	st.
1065300	17x2,0-R ¹ / ₂ "MT	25	1	st.
1065305	20x1,9/2,0-R ³ / ₄ "MT	25	1	st.

Uponor Tacker

art.nr.	omschrijving	LE	VPE	eenheid
 1065295	14x2,0-Rp½"FT	25	1	st.
1065298	16x1,8/2,0-Rp½"FT	25	1	st.
1065306	20x1,9/2,0-Rp¾"FT	25	1	st.

Uponor Rapex perskoppeling

 1005079	17-17	100	10	st.
--	-------	-----	----	-----

Voor het maken van de persverbinding de volgende Uponor persbekken toepassen (zie Uponor gereedschap):

Uponor persbek voor 17 x 2 mm PE-X artikelnummer 1006343

Uponor Q&E koppeling met ringen DR

 1058660	16x1,8/2,0-16x1,8/2,0	100	10	st.
1058661	17-17	100	10	st.

Uponor MLCP RED leiding

 1096010	14x1,6 240m	3120	240	m
1096011	14x1,6 480m	3360	480	m
1096012	16x2,0 240m	3120	240	m
1096013	16x2,0 480m	3360	480	m

Uponor Vario klemkoppeling MLCP RED

 1000117	14x1,6-¾"Euro	80	20	st.
--	---------------	----	----	-----

Uponor MLCP RED perskoppeling

 1048272	14x1,6-14x1,6	80	20	st.
--	---------------	----	----	-----

Uponor Uni-X schroefkoppeling MLC

 1058090	16-¾"FT Euro	25	1	st.
--	--------------	----	---	-----

Uponor S-Press PLUS koppeling

 1070547	16-16	80	20	st.
--	-------	----	----	-----

Uponor S-Press PLUS koppeling PPSU

 1039933	16-16	80	20	st.
--	-------	----	----	-----

art.nr.	omschrijving	LE	VPE	eenheid
---------	--------------	----	-----	---------

Uponor Fix bevestigingsclip

 1086533		5000	500	st.
--	--	------	-----	-----

Uponor Tacker clips

 1086529	14-20mm h=40mm	75000	1000	st.
--	----------------	-------	------	-----

Uponor Tacker clips lang

 1086530	55mm	4800	300	st.
--	------	------	-----	-----

Uponor Tacker Tool

 1119039	14-20mm	50	1	st.
--	---------	----	---	-----

Uponor Fix klemprofiel, zelfklevend

 1000018	14-20mm c/c50mm 1m	600	100	m
--	--------------------	-----	-----	---

Uponor Multi leiding geleidebocht kunststof

 1000118	18	250	50	st.
1001229	20	2300	50	st.

Uponor Fix

art.nr.	omschrijving	LE	VPE	eenheid
---------	--------------	----	-----	---------

Uponor Fix Klemmenstrook

	1005498 14mm c/c50mm 2,5m	-	25	m
---	----------------------------------	---	----	---

Uponor Fix Klemmenstrook

	1005274 9,9mm c/c20mm 2,5m	25	2,5	m
---	-----------------------------------	----	-----	---

Uponor Comfort Pipe PLUS leiding

	1062883 14x2,0 120m	1320	120	m
	1062884 14x2,0 240m	1680	240	m
	1062885 14x2,0 960m	1920	960	m
	1009229 20x2,0 60m	660	60	m

Uponor Minitec leiding Comfort Pipe

	1063287 9,9x1,1 60m	840	60	m
	1063288 9,9x1,1 120m	1680	120	m
	1063381 9,9x1,1 480m	2880	480	m

Uponor Magna pipe PLUS

	1091275 20x2,0 240m	960	240	m
--	----------------------------	-----	-----	---

Uponor Vario klemringschroefkoppeling PEX

	1065283 14x2,0-G $\frac{3}{4}$ "FT Euro	25	1	st.
	1065290 20x1,9/2,0-G $\frac{3}{4}$ "FT Euro	25	1	st.

Uponor Smart perskoppeling

	1089646 14x2,0-14x2,0	80	20	st.
---	------------------------------	----	----	-----

Let op: pers met Uponor S-Press persbekken UPP1 voor Uponor MLC perskoppelingen of mini persbekken KSP0

Uponor Fit klemovergangspuntstuk PEX

	1065294 14x2,0-R $\frac{1}{2}$ "MT	25	1	st.
---	---	----	---	-----

Uponor Fit klemovergangsschroefbus PEX

	1065295 14x2,0-Rp $\frac{1}{2}$ "FT	25	1	st.
---	--	----	---	-----

Uponor Q&E koppeling met ringen DR

	1058659 14-14	100	10	st.
---	----------------------	-----	----	-----

Uponor Q&E ring met stop-edge natural, eval

	1058428 14	900	20	st.
---	-------------------	-----	----	-----

Uponor Q&E zekeringsring white

	1057454 20	520	20	st.
---	-------------------	-----	----	-----

art.nr.	omschrijving	LE	VPE	eenheid
---------	--------------	----	-----	---------

Uponor MLCP RED leiding

	1096010 14x1,6 240m	3120	240	m
	1096011 14x1,6 480m	3360	480	m

Uponor Vario klemkoppeling MLCP RED

	1000117 14x1,6- $\frac{3}{4}$ "Euro	80	20	st.
---	--	----	----	-----

Uponor MLCP RED perskoppeling

	1048272 14x1,6-14x1,6	80	20	st.
---	------------------------------	----	----	-----

Uponor Minitec ring

	1005263 9,9x1,1	1600	10	st.
---	------------------------	------	----	-----

Uponor Vario Euroconus schroefkoppeling Minitec

	1005266 9,9x1,1-G $\frac{3}{4}$ "Euro	100	10	st.
---	--	-----	----	-----

Uponor Minitec koppeling

	1005264 9,9x1,1	100	10	st.
--	------------------------	-----	----	-----

Uponor Minitec T-stuk verlopend Q&E

	1020524 20xMinitec9,9xQ&E20	75	5	st.
---	------------------------------------	----	---	-----

Uponor Minitec puntstuk

	1005265 9,9-R $\frac{1}{2}$ "MT	100	10	st.
---	--	-----	----	-----

Uponor Minitec koppeling verlopend Q&E

	1020518 20xMinitec9,9	150	5	st.
---	------------------------------	-----	---	-----

Uponor Minitec Compressiefitting

	NEW 1013426 9,9- $\frac{3}{4}$ "Euro	120	12	st.
---	--	-----	----	-----

Uponor Minitec expansiegereedschap

	1006247 9,9x1,1	11	1	set
---	------------------------	----	---	-----

Uponor Q&E expansiegereedschap met expansiekop M12

	1063112 6BAR 9,9/20	-	1	set
---	----------------------------	---	---	-----

Uponor Multi geleidebocht kunststof

	1063781 12	500	50	st.
---	-------------------	-----	----	-----

Installatie

Verwarming en koeling

Warmte- en koudedistributie

Gereedschappen

Bijlage

Uponor Classic

art.nr.	omschrijving	LE	VPE	eenheid
---------	--------------	----	-----	---------

Uponor Classic Draagelement

 1005084	100mm 2100x1200x3mm	750	25	m ²
1005087	150mm 2100x1200x3mm	750	25	m ²

Uponor Classic mattenbinder

 1007393	80mm (100pce/set)	2500	50	set
--	-------------------	------	----	-----

Uponor Classic masterclip, draadstaamat

 1005188	16mm 3mm	500	500	st.
1005189	17mm 3mm	500	500	st.
1005190	20mm 3mm	2800	280	st.

Uponor Multi randisolatie met foliestrook

 1000079	150x8mm	-	200	m
--	---------	---	-----	---

Uponor Multi randisolatie met foliestrook

 1000080	150x10mm	-	200	m
--	----------	---	-----	---

Uponor Multi dilatatieprofiel

 1090229	1800x100x10mm	720	18	m
--	---------------	-----	----	---

Uponor Multi beschermingsmantel

 1000082	20mm 300x5mm	10800	30	st.
--	--------------	-------	----	-----

Uponor Comfort Pipe PLUS leiding

 1062044	16x2,0 120m	1080	120	m
1062045	16x2,0 240m	1440	240	m
1062046	16x2,0 640m	1280	640	m
1034535	17x2,0 120m	840	120	m
1009226	17x2,0 240m	1200	240	m
1086340	17x2,0 480m	960	480	m
1009227	17x2,0 640m	1280	640	m

Uponor Magna pipe PLUS

 1091275	20x2,0 240m	960	240	m
1091276	20x2,0 480m	960	480	m

Uponor Vario klemringschroefkoppeling PEX

 1065284	16x1,8/2,0-G ³ / ₄ "FT Euro	25	1	st.
1065286	17x2,0-G ³ / ₄ "FT Euro	25	1	st.
1065290	20x1,9/2,0-G ³ / ₄ "FT Euro	25	1	st.

Uponor Fit schroefkoppeling PEX

 1065296	16x1,8/2,0-16x1,8/2,0	25	1	st.
1065299	17x2,0-17x2,0	25	1	st.
1065302	20x1,9/2,0-20x1,9/2,0	25	1	st.

art.nr.	omschrijving	LE	VPE	eenheid
---------	--------------	----	-----	---------

Uponor Smart perskoppeling

 1089648	20x2,0-20x2,0	80	20	st.
--	---------------	----	----	-----

Let op: pers met Uponor S-Press persbekken UPP1 voor Uponor MLC perskoppelingen of mini persbekken KSP0

Uponor Fit klemovergangspuntstuk PEX

 1065297	16x1,8/2,0-R ¹ / ₂ "MT	25	1	st.
1065300	17x2,0-R ¹ / ₂ "MT	25	1	st.
1065305	20x1,9/2,0-R ³ / ₄ "MT	25	1	st.

Uponor Fit klemovergangsschroefbus PEX

 1065298	16x1,8/2,0-Rp ¹ / ₂ "FT	25	1	st.
1065306	20x1,9/2,0-Rp ³ / ₄ "FT	25	1	st.

Uponor Rapex perskoppeling

 1005079	17-17	100	10	st.
--	-------	-----	----	-----

Voor het maken van de persverbinding de volgende Uponor persbekken toepassen (zie Uponor gereedschap):

Uponor persbek voor 17 x 2 mm PE-X artikelnummer 1006343

Uponor Q&E koppeling met ringen DR

 1058660	16x1,8/2,0-16x1,8/2,0	100	10	st.
1058661	17-17	100	10	st.
1058668	20-20	80	10	st.

Uponor Multi leiding geleidebocht kunststof

 1000118	18	250	50	st.
1001229	20	2300	50	st.

Uponor Classic Clipmaster

 1006295	16/17mm l=920mm	100	1	st.
1006309	20mm l=920mm	-	1	st.

Uponor Classic drilapparaat voor matbinders

 1006243	l=320mm	50	1	st.
--	---------	----	---	-----

Uponor Siccus 14

art.nr.	omschrijving	LE	VPE	eenheid
---------	--------------	----	-----	---------

Uponor Siccus 14 montageplaat

	1005485 EPS 150kPa 14mm 1197x1050x25mm	100	12,5	m ²
---	---	-----	------	----------------

Uponor Siccus 14 warmtegeleidingslamel

	1005486 14mm 1180x120x0,45mm	768	48	st.
---	-------------------------------------	-----	----	-----

Uponor Multi randisolatie met foliestrook

	1000079 150x8mm	-	200	m
---	------------------------	---	-----	---

Uponor Comfort Pipe PLUS leiding

	1062883 14x2,0 120m	1320	120	m
	1062884 14x2,0 240m	1680	240	m
	1088166 14x2,0 640m	1920	640	m
	1062885 14x2,0 960m	1920	960	m

Uponor Vario klemringschroefkoppeling PEX

	1065283 14x2,0-G¾"FT Euro	25	1	st.
--	----------------------------------	----	---	-----

Uponor Fit klemovergangspuntstuk PEX

	1065294 14x2,0-R½"MT	25	1	st.
---	-----------------------------	----	---	-----

Uponor Fit klemovergangsschroefbus PEX

	1065295 14x2,0-Rp½"FT	25	1	st.
---	------------------------------	----	---	-----

Uponor Q&E koppeling met ringen DR

	1058659 14-14	100	10	st.
---	----------------------	-----	----	-----

Uponor Q&E ring met stop-edge natural, eval

	1058428 14	900	20	st.
---	-------------------	-----	----	-----

Uponor Smart perskoppeling

	1089646 14x2,0-14x2,0	80	20	st.
---	------------------------------	----	----	-----

Let op: pers met Uponor S-Press persbekken UPP1 voor Uponor MLC perskoppelingen of mini persbekken KSP0

art.nr.	omschrijving	LE	VPE	eenheid
---------	--------------	----	-----	---------

Uponor MLCP RED leiding

	1096010 14x1,6 240m	3120	240	m
	1096011 14x1,6 480m	3360	480	m

Uponor Vario klemkoppeling MLCP RED

	1000117 14x1,6-¾"Euro	80	20	st.
---	------------------------------	----	----	-----

Uponor MLCP RED perskoppeling

	1048272 14x1,6-14x1,6	80	20	st.
---	------------------------------	----	----	-----

Uponor Multi leiding geleidebocht kunststof

	1000118 18	250	50	st.
---	-------------------	-----	----	-----

Uponor Siccus 14 polystyreensnijder

	1006290 14mm 230V	20	1	st.
---	--------------------------	----	---	-----

Uponor Renovis

art.nr.	omschrijving	LE	VPE	eenheid
 1061173	800x625mm	-	24	st.
1061172	1200x625mm	-	24	st.
1061171	2000x625mm	-	24	st.

Uponor Renovis Panel extra

 1063923	800x625x15mm	24	1	st.
1063924	1200x625x15mm	24	1	st.
1063925	2000x625x15mm	24	1	st.

Uponor Renovis Panel

 1063926	2000x625x15mm	-	24	st.
--	---------------	---	----	-----

Uponor Renovis aansluitpakket

 1061165	4-6X	10	1	set
--	------	----	---	-----

Ter informatie: de in de omschrijving genoemde „4-6 loop“ betekend: 4-6 groepen

Uponor Fix Klemmenstrook

 1005274	9,9mm c/c20mm 2,5m	25	2,5	m
--	--------------------	----	-----	---

Uponor Renovis klemprofiel

 1061162	20mm l=250mm	-	15	st.
--	--------------	---	----	-----

Uponor Minitec leiding Comfort Pipe

 1063287	9,9x1,1 60m	840	60	m
1063288	9,9x1,1 120m	1680	120	m

Uponor Minitec puntstuk

 1005265	9,9-R½"MT	100	10	st.
--	-----------	-----	----	-----

Uponor Minitec koppeling

 1005264	9,9x1,1	100	10	st.
--	---------	-----	----	-----

Uponor Minitec ring

 1005263	9,9x1,1	1600	10	st.
--	---------	------	----	-----

art.nr.	omschrijving	LE	VPE	eenheid
 1009229	20x2,0 60m	660	60	m

Uponor Comfort Pipe PLUS leiding

Uponor Magna pipe PLUS

 1091275	20x2,0 240m	960	240	m
1091276	20x2,0 480m	960	480	m

Uponor Minitec T-stuk verlopend Q&E

 1020524	20xMinitec9,9xQ&E20	75	5	st.
--	---------------------	----	---	-----

Uponor Minitec koppeling verlopend Q&E

 1020518	20xMinitec9,9	150	5	st.
--	---------------	-----	---	-----

Uponor Q&E koppeling PPSU

 1008932	20-20	80	5	st.
---	-------	----	---	-----

Uponor Q&E knie 90° PPSU

 1008680	20-20	40	5	st.
--	-------	----	---	-----

Uponor Q&E zekeringsring white

 1057454	20	520	20	st.
--	----	-----	----	-----

Uponor Renovis

art.nr.	omschrijving	LE	VPE	eenheid
---------	--------------	----	-----	---------

Uponor Uni Pipe PLUS wit S

 1060784	20x2,25 3m	51	3	m
---	------------	----	---	---

Uponor Q&E T-stuk S-Press

 1063938	20-Q&E9,9-Press20	6	2	st.
---	-------------------	---	---	-----

Uponor Q&E overgang S-Press

 1063939	20-Q&E9,9	12	2	st.
---	-----------	----	---	-----

Uponor Vario aanvoer fijninregelafsluiter

 1005107	½" - G¾	50	1	st.
---	---------	----	---	-----

Uponor Vario retour fijninregelafsluiter

 1005108	½" - G¾	50	1	st.
---	---------	----	---	-----

Uponor Vario PLUS thermische aandrijving NC

 1005605	230V MT30x1,5	10	1	st.
---	---------------	----	---	-----

Uponor Base ruimtethermostaat T-23

 1058422	230V RAL9010	160	1	st.
---	--------------	-----	---	-----

Uponor Minitec expansiegereedschap

 1006247	9,9x1,1	11	1	set
---	---------	----	---	-----

Uponor Q&E expansiegereedschap met expansiekop M12

 1063112	6BAR 9,9/20	-	1	set
---	-------------	---	---	-----

Uponor Q&E RS expansiegereedschap met expansiekop M12

 NEW 1119375	6bar 9,9RS/20	-	1	set
--	---------------	---	---	-----

Uponor Multi geleidebocht kunststof

 1063781	12	500	50	st.
---	----	-----	----	-----

Uponor Comfort E

art.nr.	omschrijving	LE	VPE	eenheid
---------	--------------	----	-----	---------

Uponor Comfort E kabelmat set T-87IF

 1088668	160-1	50	1	set
1088669	160-1,5	50	1	set
1088670	160-2	50	1	set
1088671	160-2,5	50	1	set
1088672	160-3	50	1	set
1088673	160-4	35	1	set
1088674	160-5	35	1	set
1088675	160-6	35	1	set
1088676	160-7	20	1	set
1088677	160-8	20	1	set
1088678	160-10	20	1	set
1088679	160-12	20	1	set

Uponor Comfort E kabelmat

 1088656	160-1	50	1	set
1088657	160-1,5	50	1	set
1088658	160-2	50	1	set
1088659	160-2,5	50	1	set
1088660	160-3	50	1	set
1088661	160-4	35	1	set
1088662	160-5	35	1	set
1088663	160-6	35	1	set
1088664	160-7	20	1	set
1088665	160-8	20	1	set
1088666	160-10	20	1	set
1088667	160-12	20	1	set

Uponor Comfort E ruimtethermostaat set T-85

 1088705	230V	-	1	set
---	------	---	---	-----

Uponor Comfort E ruimtetherm. digi. pro. flush Set T-86

 1088819	230V	-	1	set
---	------	---	---	-----

Uponor Comfort E ruimtetherm. digi. pro. flush Set T-87IF

 1088706	230V	-	1	set
---	------	---	---	-----

Uponor Comfort E vloersensor T-85, T-87

 1090944		100	1	st.
---	--	-----	---	-----

Uponor Siccus wall

art.nr.	omschrijving	LE	VPE	eenheid
---------	--------------	----	-----	---------

Uponor Siccus 14 montageplaat

	1005485 EPS 150kPa 14mm 1197x1050x25mm	100	12,5	m ²
---	--	-----	------	----------------

Uponor Siccus 14 warmtegeleidingslamel

	1005486 14mm 1180x120x0,45mm	768	48	st.
---	--	-----	----	-----

Uponor Comfort Pipe PLUS leiding

	1062883 14x2,0 120m	1320	120	m
	1062884 14x2,0 240m	1680	240	m
	1062885 14x2,0 960m	1920	960	m

Uponor Vario klemringschroefkoppeling PEX

	1065283 14x2,0-G¾"FT Euro	25	1	st.
---	----------------------------------	----	---	-----

Uponor Fit klemovergangspuntstuk PEX

	1065294 14x2,0-R½"MT	25	1	st.
---	-----------------------------	----	---	-----

Uponor Fit klemovergangsschroefbus PEX

	1065295 14x2,0-Rp½"FT	25	1	st.
---	------------------------------	----	---	-----

Uponor Q&E koppeling met ringen DR

	1058659 14-14	100	10	st.
---	----------------------	-----	----	-----

Uponor Q&E ring met stop-edge natural, eval

	1058428 14	900	20	st.
---	-------------------	-----	----	-----

Uponor Smart perskoppeling

	1089646 14x2,0-14x2,0	80	20	st.
---	------------------------------	----	----	-----

Let op: pers met Uponor S-Press persbekken UPP1 voor Uponor MLC perskoppelingen of mini persbekken KSP0

Uponor MLCP RED leiding

	1096010 14x1,6 240m	3120	240	m
	1096011 14x1,6 480m	3360	480	m

Uponor Vario klemkoppeling MLCP RED

	1000117 14x1,6-¾"Euro	80	20	st.
---	------------------------------	----	----	-----

Uponor MLCP RED perskoppeling

	1048272 14x1,6-14x1,6	80	20	st.
---	------------------------------	----	----	-----

Uponor Siccus SW

art.nr.	omschrijving	LE	VPE	eenheid
---------	--------------	----	-----	---------

Uponor Siccus SW wandelement

	OUT 1005499 14mm 1150x615mm	56,6	2,83	m ²
---	---------------------------------------	------	------	----------------

OUT Artikel is uitlopend.
Levering zolang de voorraad strekt.

Uponor Comfort Pipe PLUS leiding

	1062883 14x2,0 120m	1320	120	m
	1062884 14x2,0 240m	1680	240	m

Uponor Vario klemringschroefkoppeling PEX

	1065283 14x2,0-G¾"FT Euro	25	1	st.
---	----------------------------------	----	---	-----

Uponor Fit klemovergangspuntstuk PEX

	1065294 14x2,0-R½"MT	25	1	st.
---	-----------------------------	----	---	-----

Uponor Fit klemovergangsschroefbus PEX

	1065295 14x2,0-Rp½"FT	25	1	st.
---	------------------------------	----	---	-----

Uponor Q&E koppeling met ringen DR

	1058659 14-14	100	10	st.
---	----------------------	-----	----	-----

Uponor Q&E ring met stop-edge natural, eval

	1058428 14	900	20	st.
---	-------------------	-----	----	-----

Uponor Siccus 14 polystyreensnijder

	1006290 14mm 230V	20	1	st.
---	--------------------------	----	---	-----

Uponor Thermatop

art.nr.	omschrijving	LE	VPE	eenheid
Uponor Thermatop M				
 1090933	950x277mm	200	10	st.
1090934	1350X277mm	200	10	st.
1090935	1750X277mm	200	10	st.
1090936	2150X277mm	200	10	st.
1090937	2550x277mm	200	10	st.

art.nr.	omschrijving	LE	VPE	eenheid
Uponor Uni-X schroefkoppeling MLC				
 1058090	16-3/4"FT Euro	25	1	St.
Uponor S-Press PLUS koppeling				
 1070547	16-16	80	10	St.

Uponor S-Press PLUS koppeling PPSU				
 1039933	16-16	80	10	St.



Installatie

Verwarming en koeling

Warmte- en koudedistributie

Gereedschappen

Bijlage

Uponor Multi

art.nr.	omschrijving	LE	VPE	een- heid
---------	--------------	----	-----	--------------

Uponor Multi leidingbinder PA

 1005372	300mm	5000	100	st.
--	-------	------	-----	-----

Uponor Multi leidingbinder PA

 1086531	200mm	10000	100	st.
--	-------	-------	-----	-----

Uponor Multi montageprofiel

 1005358	20mm c/c50mm 3m	30	3	m
--	-----------------	----	---	---

Uponor Multi folie PE100 PE

 1005051	0,1mm 75x2m	6900	150	m ²
--	-------------	------	-----	----------------

Uponor Multi folie PE200 PE

 1005049	0,2mm 60x1,25m	3375	75	m ²
---	----------------	------	----	----------------

LET OP: verkoop per verpakkingseenheid van 1 rol (75 m²) = € 86,25

Uponor Multi noppenfolie

 1000017	4mm 60x1m	-	60	m ²
--	-----------	---	----	----------------



Uponor Multi rasterfolie

 1000015	0,25mm 100x1,03m	2472	103	m ²
--	------------------	------	-----	----------------

Uponor Multi folienagel

 1000016	l=25mm	5000	100	st.
--	--------	------	-----	-----

Uponor Multi randisolatie zelfklevend PE

 1013117	40m 100x10mm	-	240	m
 1000080	150x10mm	-	200	m

art.nr.	omschrijving	LE	VPE	een- heid
---------	--------------	----	-----	--------------

Uponor Multi randisolatie met foliestrook

 1000079	150x8mm	-	200	m
--	---------	---	-----	---

Uponor Multi dilatatieprofiel

 1090229	1800x100x10mm	720	18	m
--	---------------	-----	----	---

Uponor Multi beschermingsmantel

 1000082	20mm 300x5mm	10800	30	st.
--	--------------	-------	----	-----

Uponor Multi cementcomponent VD 450

 1000084	20L	480	20	l
--	-----	-----	----	---

LET OP: het cementcomponent dient tegen vorst en UV-straling beschermd te worden. Dit product is uitgesloten van retourname door Uponor.

Uponor Multi cementcomponent, snel droog VD 550 N

 1000085	25L	600	25	l
--	-----	-----	----	---

LET OP: het cementcomponent dient tegen vorst en UV-straling beschermd te worden. Dit product is uitgesloten van retourname door Uponor.

Uponor Multi markeringsset

 1000083	100mm	-	10	st.
--	-------	---	----	-----

Uponor Multi gebonden gietvloer

 1000052	100l	2500	100	l
--	------	------	-----	---

LET OP: verkoop per verpakkingseenheid

Uponor Multi antivriesmiddel

 1005066	≥ -30C 20l	480	20	l
--	------------	-----	----	---

Verdeel- en stijgleidingen 25-75 mm

art.nr.	omschrijving	LE	VPE	eenheid
Uponor Uni Pipe PLUS wit S				
 1060785	25x2,5 3m	30	3	m
1060786	32x3,0 3m	21	3	m

art.nr.	omschrijving	LE	VPE	eenheid
Uponor MLC leiding wit S				
 1013448	40x4,0 3m	12	3	m
1021980	50x4,5 3m	12	3	m
1021981	63x6,0 3m	9	3	m
1013453	75x7,5 5m	255	5	m

art.nr.	omschrijving	LE	VPE	eenheid
Uponor S-Press PLUS koppeling PPSU				
 1039935	25-25	80	10	st.
1039936	32-32	80	10	st.

art.nr.	omschrijving	LE	VPE	eenheid
Uponor S-Press composiet koppeling PPSU				
 1046401	40-40	960	5	st.
1046402	50-50	576	3	st.
1032881	63-63	384	1	st.
1032882	75-75	384	1	st.

art.nr.	omschrijving	LE	VPE	eenheid
Uponor S-Press PLUS koppeling verlopend PPSU				
 1039940	32-25	80	10	st.

art.nr.	omschrijving	LE	VPE	eenheid
Uponor S-Press koppeling verlopend PPSU				
 1039941	40-25	960	5	st.
1039942	40-32	960	5	st.
1039943	50-32	1152	3	st.

art.nr.	omschrijving	LE	VPE	eenheid
Uponor S-Press composiet koppeling verlopend PPSU				
 1046406	50-40	576	3	st.
1032883	63-40	384	1	st.
1032884	63-50	384	1	st.
1032885	75-50	384	1	st.
1032886	75-63	384	1	st.

art.nr.	omschrijving	LE	VPE	eenheid
Uponor S-Press PLUS knie 90° PPSU				
 1039931	25-25	80	10	st.
1039932	32-32	20	5	st.

art.nr.	omschrijving	LE	VPE	eenheid
Uponor S-Press composiet knie 90° PPSU				
 1046386	40-40	960	5	st.
1046387	50-50	576	3	st.
1032877	63-63	210	1	st.
1032878	75-75	210	1	st.

art.nr.	omschrijving	LE	VPE	eenheid
Uponor S-Press composiet knie 45° PPSU				
 1046388	40-40	960	5	st.
1046389	50-50	576	3	st.
1032879	63-63	192	1	st.
1032880	75-75	192	1	st.

art.nr.	omschrijving	LE	VPE	eenheid
Uponor S-Press PLUS T-stuk PPSU				
 1039946	25-25-25	20	5	st.
1039947	32-32-32	20	5	st.

art.nr.	omschrijving	LE	VPE	eenheid
Uponor S-Press composiet T-stuk PPSU				
 1046390	40-40-40	720	5	st.
1046391	50-50-50	288	3	st.
1032887	63-63-63	150	1	st.
1032888	75-75-75	150	1	st.

art.nr.	omschrijving	LE	VPE	eenheid
Uponor S-Press PLUS T-stuk binnendraad				
 1070598	25-Rp $\frac{1}{2}$ "FT-25	20	5	st.
1070600	32-Rp $\frac{1}{2}$ "FT-32	20	5	st.

art.nr.	omschrijving	LE	VPE	eenheid
Uponor S-Press T-stuk binnendraad				
 1046922	40-Rp $\frac{1}{2}$ "FT-40	500	5	st.
1046929	50-Rp1"FT-50	240	3	st.













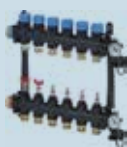
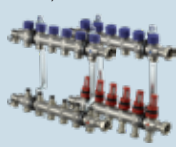
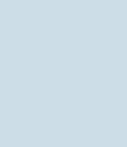

art.nr.	omschrijving	LE	VPE	eenheid
Uponor S-Press PLUS puntstuk				
 1070507	25-R $\frac{3}{4}$ "MT	80	10	st.
1070508	25-R1"MT	40	5	st.
1070509	32-R1"MT	40	5	st.
1070510	32-R1 $\frac{1}{4}$ "MT	20	5	st.

art.nr.	omschrijving	LE	VPE	eenheid
Uponor S-Press puntstuk				
 1046901	40-R1 $\frac{1}{4}$ "MT	960	5	st.
1046902	40-R1 $\frac{1}{2}$ "MT	960	5	st.
1046905	50-R1 $\frac{1}{2}$ "MT	1152	3	st.
1046906	50-R2"MT	576	3	st.
1032895	63-R2"MT	336	1	st.
1032896	75-R2 $\frac{1}{2}$ "MT	336	1	st.

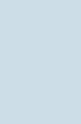
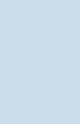
art.nr.	omschrijving	LE	VPE	eenheid
Uponor S-Press PLUS schroefbus				
 1070519	25-Rp $\frac{3}{4}$ "FT	40	5	st.
1070520	25-Rp1"FT	40	5	st.
1070521	32-Rp1"FT	40	5	st.
1070522	32-Rp1 $\frac{1}{4}$ "FT	20	5	st.

art.nr.	omschrijving	LE	VPE	eenheid
Uponor S-Press schroefbus				
 1046903	40-Rp1 $\frac{1}{4}$ "FT	960	5	st.
1046904	40-Rp1 $\frac{1}{2}$ "FT	960	5	st.
1046907	50-Rp1 $\frac{1}{2}$ "FT	1152	3	st.

Uponor stelaandrijvingen en -adapters

Thermische aandrijving		Geschikt voor verdeler				
Uponor Vario PLUS thermische aandrijving PRO MT 30x1,5 		Uponor Vario PLUS 	Uponor Magna industriële verwarmingsverdeler 	Uponor Vario Regulierventiel 	Uponor Vario RL-ventiel 	
Omschrijving	art.nr.				pagina	
24 V	1000138				51	
230 V	1005605				51	
Uponor Vario thermische aandrijving S FT 30x1,5 		Vario S Roestvrijstaalen verdeler ST FM en LS 	Vario M met debietmeter FM 	Vario S Roestvrijstaalen verdeler ST LS en FM (t/m 2018) 	Vervangonderdeel Chronatherm 	
Omschrijving	art.nr.				pagina	
24 V	1020262				53, 60	
230 V	1020261				53	
Uponor Vario B thermische aandrijving PRO FT 28x1,5 		Vervangonderdeel Uponor Fluvia T 	Vervangonderdeel Unipipe 	Vervangonderdeel 28x1.5 		
Omschrijving	art.nr.				pagina	
24 V	1007249				61	
230 V	1022244				61	
Uponor Vario PLUS Adapter VA 02 30 x 1,5 AG 		Vervangonderdelen Velta Kompakt en Velta Euro-Verdeler 				
Omschrijving	art.nr.					
24 V	1090262					
230 V	1090263					
Uponor Vario B Adapter VA 32 28 x 1,5 IG 		Vervangonderdeel Polytherm zonder DF 	Vervangonderdeel Polytherm DF 			
Omschrijving	art.nr.					
24 V	1090264					
230 V	1090265					

Uponor Vario PLUS

art.nr.	omschrijving	LE	VPE	eenheid
Uponor Vario PLUS verdeler met ventiel				
 1042420	LS 1X 3/4 Euro	10	1	set
1030580	LS 3X 3/4 Euro	290	1	set
1030581	LS 4X 3/4 Euro	225	1	set
1030582	LS 6X 3/4 Euro	155	1	set

art.nr.	omschrijving	LE	VPE	eenheid
Uponor Vario PLUS verdeler m.debietmeter				
 1042471	FM 1X 3/4 Euro	10	1	set
1030583	FM 3X 3/4 Euro	174	1	set
1030584	FM 4X 3/4 Euro	135	1	set
1030585	FM 6X 3/4 Euro	93	1	set

art.nr.	omschrijving	LE	VPE	eenheid
Uponor Vario PLUS verdeler set				
 1009209	K1	248	1	st.

art.nr.	omschrijving	LE	VPE	eenheid
Uponor Vario PLUS thermische aandrijving NC				
 1000138	24V MT30x1,5	10	1	st.
1005605	230V MT30x1,5	10	1	st.

art.nr.	omschrijving	LE	VPE	eenheid
Uponor Vario PLUS elektrothermische aandrijving 100kOhm				
 1005544	24V NC MT30x1,5 0-10V DC	100	1	st.

art.nr.	omschrijving	LE	VPE	eenheid
Uponor Vario klemringschroefkoppeling PEX				
 1065283	14x2,0-G3/4 FT Euro	25	1	st.
1065284	16x1,8/2,0-G3/4 FT Euro	25	1	st.
1065286	17x2,0-G3/4 FT Euro	25	1	st.
1065290	20x1,9/2,0-G3/4 FT Euro	25	1	st.

art.nr.	omschrijving	LE	VPE	eenheid
Uponor Vario PLUS aansluitset haaks				
 1032702	122/42	5	1	set

art.nr.	omschrijving	LE	VPE	eenheid
Uponor Vario PLUS aansluitset				
 1005227		10	1	set

art.nr.	omschrijving	LE	VPE	eenheid
Uponor Vario PLUS tule vulslang				
 1009214	G3/4 x 1/2	10	1	st.

art.nr.	omschrijving	LE	VPE	eenheid
Uponor Vario PLUS afstandsringset				
 1009215		10	1	st.

art.nr.	omschrijving	LE	VPE	eenheid
Uponor Vario PLUS isolatieset				
 1063207		-	1	set

art.nr.	omschrijving	LE	VPE	eenheid
Uponor Vario benamingssticker				
 1005063	47x10mm	-	1	set



art.nr.	omschrijving	LE	VPE	eenheid
Uponor Vario PLUS klik-therm. 0-60°C				
 1034524	D=40mm	20	1	set

art.nr.	omschrijving	LE	VPE	eenheid
Uponor Vario PLUS debietmeter				
 1009217	4 l/min	20	1	st.

art.nr.	omschrijving	LE	VPE	eenheid
Uponor Vario PLUS aanvoerventiel-insert scale 1-5				
 1034523		-	20	st.

Uponor Vario M

art.nr.	omschrijving	LE	VPE	eenheid
Uponor Vario M verdeler met debietmeter FM				
 1085944	2X G $\frac{3}{4}$ Euro	80	1	st.
1085945	3X G $\frac{3}{4}$ Euro	80	1	st.
1085946	4X G $\frac{3}{4}$ Euro	80	1	st.
1085947	5X G $\frac{3}{4}$ Euro	80	1	st.
1085948	6X G $\frac{3}{4}$ Euro	80	1	st.
1085949	7X G $\frac{3}{4}$ Euro	80	1	st.
1085950	8X G $\frac{3}{4}$ Euro	80	1	st.
1085951	9X G $\frac{3}{4}$ Euro	80	1	st.
1085952	10X G $\frac{3}{4}$ Euro	80	1	st.
1086250	11X G $\frac{3}{4}$ Euro	108	1	st.
1086251	12X G $\frac{3}{4}$ Euro	108	1	st.
1087129	13X G $\frac{3}{4}$ Euro	30	1	st.
1087130	14X G $\frac{3}{4}$ Euro	30	1	st.
1087131	15X G $\frac{3}{4}$ Euro	30	1	st.

art.nr.	omschrijving	LE	VPE	eenheid
Uponor Vario M Spruitstuk - Debietmeter				
 NEW 1121531	0-5l/min	10	1	st.
Uponor Vario M houder				
 1087531		-	1	set
Uponor Vario benamingssticker				
 1005063	47x10mm	-	1	set

Uponor Vario S

art.nr.	omschrijving	LE	VPE	eenheid
Uponor Vario S verdeler FM				
 1086538	2X $\frac{3}{4}$ Euro	108	1	st.
1086539	3x $\frac{3}{4}$ Euro	108	1	st.
1086540	4x $\frac{3}{4}$ Euro	108	1	st.
1086541	5x $\frac{3}{4}$ Euro	108	1	st.
1086542	6x $\frac{3}{4}$ Euro	72	1	st.
1086543	7X $\frac{3}{4}$ Euro	72	1	st.
1086544	8x $\frac{3}{4}$ Euro	72	1	st.
1086545	9x $\frac{3}{4}$ Euro	72	1	st.
1086546	10x $\frac{3}{4}$ Euro	48	1	st.
1086547	11x $\frac{3}{4}$ Euro	48	1	st.
1086548	12x $\frac{3}{4}$ Euro	48	1	st.
1088864	13x $\frac{3}{4}$ Euro	48	1	st.
1088865	14X $\frac{3}{4}$ Euro	36	1	st.
1088866	15x $\frac{3}{4}$ Euro	36	1	st.
1088867	16x $\frac{3}{4}$ Euro	36	1	st.

art.nr.	omschrijving	LE	VPE	eenheid
Uponor Vario S verdeler LS				
 1088045	2X $\frac{3}{4}$ Euro	108	1	st.
1088046	3X $\frac{3}{4}$ Euro	108	1	st.
1088047	4X $\frac{3}{4}$ Euro	108	1	st.
1088048	5X $\frac{3}{4}$ Euro	108	1	st.
1088049	6X $\frac{3}{4}$ Euro	72	1	st.
1088050	7X $\frac{3}{4}$ Euro	72	1	st.
1088051	8X $\frac{3}{4}$ Euro	72	1	st.
1088052	9X $\frac{3}{4}$ Euro	72	1	st.
1088053	10X $\frac{3}{4}$ Euro	48	1	st.
1088054	11X $\frac{3}{4}$ Euro	48	1	st.
1088055	12x $\frac{3}{4}$ Euro	48	1	st.
1088868	13x $\frac{3}{4}$ Euro	48	1	st.
1088869	14x $\frac{3}{4}$ Euro	36	1	st.
1088870	15X $\frac{3}{4}$ Euro	36	1	st.
1088871	16X $\frac{3}{4}$ Euro	36	1	st.

Uponor Vario S

art.nr.	omschrijving	LE	VPE	eenheid
---------	--------------	----	-----	---------

Uponor Vario thermische aandrijving NL NC

 1020261	230V FT30X1,5	100	1	st.
--	---------------	-----	---	-----

Uponor Vario thermische aandrijving NL NC

 1020262	24V FT30X1,5	100	1	st.
--	--------------	-----	---	-----

Uponor Vario benamingssticker

 1005063	47x10mm	-	1	set
--	---------	---	---	-----

Uponor Vario verdeler-inregelventiel

 1005100	G1 - Rp1	10	1	set
--	----------	----	---	-----

Uponor Vario kogelkraan

 1059132	NP G1-G1	10	1	set
--	----------	----	---	-----

Uponor Vario kogelkraan

 1086558	¼-G1	10	1	set
--	------	----	---	-----

Uponor Vario kogelkraan haaks

 1086559	Rp ¼" - G1"	-	1	set
--	-------------	---	---	-----

 1090732	G1-Rp1	260	1	set
--	--------	-----	---	-----

Uponor Vario aansluitstuk

 1058573	G1-G1A	30	1	st.
--	--------	----	---	-----

Uponor Vario aanvoer fijnregelafsluiter

 1005107	½" - G¾	50	1	st.
--	---------	----	---	-----

Uponor Vario retour fijnregelafsluiter

 1005108	½" - G¾	50	1	st.
--	---------	----	---	-----

art.nr.	omschrijving	LE	VPE	eenheid
---------	--------------	----	-----	---------

Uponor Vario WM aansluiting horizontaal

 1090730	G¾" 110mm	250	1	set
--	-----------	-----	---	-----

 1090728	G1" 130mm	-	1	set
--	-----------	---	---	-----

Uponor Vario WM aansluiting verticaal

 1090731	G¾" 110mm	250	1	set
--	-----------	-----	---	-----

 1090729	G1" 130mm	250	1	set
--	-----------	-----	---	-----

Uponor Vario koppeling voor WM-sensor

 1007177	M10-5mm	-	1	st.
--	---------	---	---	-----

Uponor Vario aansluitknie

 1000110	1"FT-1"MT	50	10	st.
--	-----------	----	----	-----

Uponor Aqua PLUS verdelerkap met vlakdichting

 1001337	¼"FT	250	10	st.
---	------	-----	----	-----

Uponor Vario S thermometer

 1086537		10	1	set
--	--	----	---	-----

Uponor Vario S S LS verd. aanv.vent. LS

 1088056		-	10	st.
--	--	---	----	-----

Afmetingen verdelerkast

Montageopties en inbouwmaten

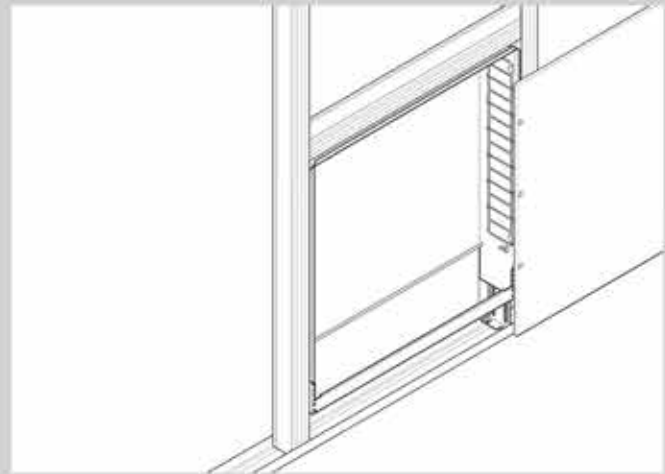
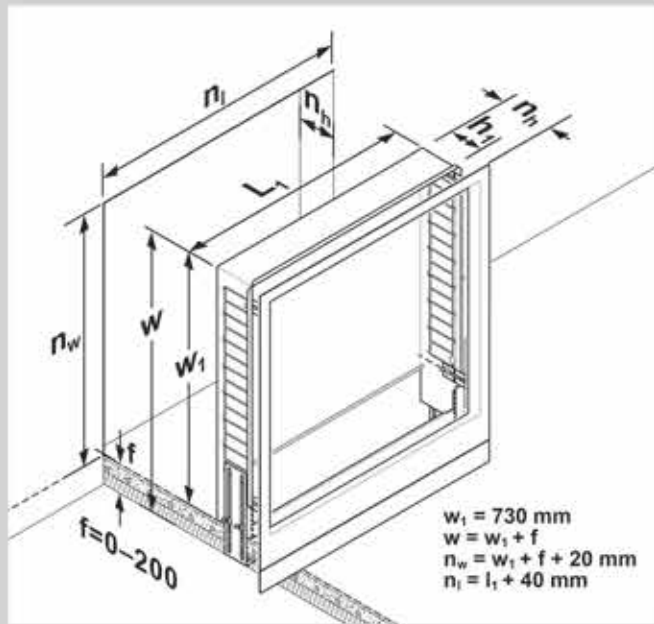

met Uponor Vario PLUS verdeler	Va-riant	Aansluitsituatie	verdelerkast breedte l_1 (mm)						h_1 (mm)	n_{h1} min. (mm)
			550	700	850	1000	1150	1300		
geschikt voor aantal groepen										
	1	Verticaal (zonder Vario WMZ-aansluitset)	2-4	5-7	8-10	11-13	14-15	-	80	80*
	2	Verticaal (met Vario WMZ-aansluitset)	2-4	5-7	8-10	11-13	14-15	-	80	95
	3	Zijdelings (zonder Vario WMZ-aansluitset)	2-5	6-8	9-11	12-14	15	-	80	80*
	4	Zijdelings (met Vario WMZ-aansluitset)	-	2-3	4-6	7-9	10-12	13-15	80	95
	5	Met pompgroep Push 23 B	2-3	4-6	7-9	10-12	13-15	-	110	110*
	6	Met pompgroep MPG 10 / Push 23 A	-	2-4	5-7	8-10	11-13	14-15	110	110*
	7	Zijdelings met Viva drukverschilregelaar en WMZ	-	2	3-5	6-8	9-11	12-14	80	80*
	8	Verticaal met Viva drukverschilregelaar en WMZ	-	2-3	4-6	7-9	10-12	13-15	80	95

met Uponor Vario M verdeler	Va-riant	Aansluitsituatie	verdelerkast breedte l_1 (mm)						h_1 (mm)	n_{h1} min. (mm)
			550	700	850	1000	1150	1300		
geschikt voor aantal groepen										
	1	Verticaal (zonder Vario WMZ-aansluitset)	2-5	6-8	9-10	11-13	14-15	-	80	80*
	2	Verticaal (met Vario WMZ-aansluitset)	2-5	6-8	9-10	11-13	14-15	-	80	95
	3	Zijdelings (zonder Vario WMZ-aansluitset)	2-6	7-9	10-11	12-14	15	-	80	80*
	4	Zijdelings (met Vario WMZ-aansluitset)	-	2-4	5-7	8-10	11-12	13-15	80	95
	5	Met pompgroep Push 23 B	2-4	5-7	8-10	11-12	13-15	-	110	110*
	6	Met pompgroep MPG 10 / Push 23 A	-	2-4	5-7	8-10	11-13	14-15	110	110*
	7	Zijdelings met Viva drukverschilregelaar en WMZ	-	2-3	4-6	7-9	10-11	12-14	80	80*
	8	Verticaal met Viva drukverschilregelaar en WMZ	-	2-4	5-7	8-10	11-12	13-15	80	95

met Uponor Vario S verdeler	Va-riant	Aansluitsituatie	verdelerkast breedte l_1 (mm)						h_1 (mm)	n_{h1} min. (mm)
			550	700	850	1000	1150	1300		
geschikt voor aantal groepen										
	1	Verticaal (zonder Vario WMZ-aansluitset)	2-5	6-8	9-11	12-14	15-16	-	80	80*
	2	Verticaal (met Vario WMZ-aansluitset)	2-5	6-8	9-11	12-14	15-16	-	80	95
	3	Zijdelings (zonder Vario WMZ-aansluitset)	2-6	7-9	10-12	13-15	16	-	80	80*
	4	Zijdelings (met Vario WMZ-aansluitset)	-	2-4	5-7	8-10	11-13	14-16	80	95
	5	Met pompgroep Push 23 B	2-4	5-7	8-10	11-13	14-16	-	110	110*
	6	Met pompgroep MPG 10 / Push 23 A	-	2-4	5-7	8-10	11-13	14-16	110	110*
	7	Zijdelings met Viva drukverschilregelaar en WMZ	-	2-3	4-6	7-9	10-12	13-15	80	80*
	8	Verticaal met Viva drukverschilregelaar en WMZ	-	2-4	5-7	8-10	11-13	14-16	80	95

WMZ = Vario WMZ-aansluitset

* plus 10 mm bij gebruik van een kunststof deur

Uponor Vario

art.nr.	omschrijving	LE	VPE	eenheid
Uponor Vario verdelerkast IW				
 1093491	550x730x110mm	18	1	st.
1093492	700x730x110mm	16	1	st.
1093493	850x730x110mm	13	1	st.
1093494	1000x730x110mm	12	1	st.
1093495	1150x730x110mm	8	1	st.
1093496	1300x730x110mm	8	1	st.

art.nr.	omschrijving	LE	VPE	eenheid
Uponor Vario verdelerkast IW				
 1093497	550x730x80mm	28	1	st.
1093498	700x730x80mm	25	1	st.
1093499	850x730x80mm	19	1	st.
1093500	1000x730x80mm	18	1	st.
1093501	1150x730x80mm	12	1	st.
1093502	1300x730x80mm	12	1	st.

art.nr.	omschrijving	LE	VPE	eenheid
Uponor Vario verdelerkast omlijsting en deur IW S				
 1093528	550x730mm	35	1	st.
1093541	700x730mm	30	1	st.
1093542	850x730mm	25	1	st.
1093543	1000x730mm	20	1	st.
1093544	1150x730mm	15	1	st.
1093546	1300x730mm	15	1	st.

art.nr.	omschrijving	LE	VPE	eenheid
Uponor Vario verdelerkast omlijsting en deur IW P				
 1093547	550x730mm	35	1	st.
1093548	700x730mm	30	1	st.
1093549	850x730mm	25	1	st.
1093550	1000x730mm	20	1	st.
1093551	1150x730mm	15	1	st.
1093552	1300x730mm	15	1	st.

art.nr.	omschrijving	LE	VPE	eenheid
Uponor Vario cilinderset met twee sleutels				
 1093554		200	1	st.

art.nr.	omschrijving	LE	VPE	eenheid
Uponor Vario rail				
 1093555		200	1	st.

art.nr.	omschrijving	LE	VPE	eenheid
Uponor Vario bevestigingsmateriaal				
 1093522	(5pcs)	200	1	st.

art.nr.	omschrijving	LE	VPE	eenheid
Uponor Vario verdelerkast opbouw AP				
 1045478	600x156mm	11	1	st.
1045479	800x156mm	10	1	st.
1045480	1000x156mm	9	1	st.
1045481	1350x156mm	8	1	st.

art.nr.	omschrijving	LE	VPE	eenheid
Uponor Vario achterwand verdelerkast AP				
 1045482	580mm	15	1	st.
1045483	780mm	30	1	st.
1045484	980mm	20	1	st.
1045485	1330mm	-	1	st.

art.nr.	omschrijving	LE	VPE	eenheid
Uponor Magna verdelerkast opbouw				
 1060553	1010x835x200mm	-	1	st.
1060554	1910x835x200mm	-	1	st.
1060555	2310x835x200mm	-	1	st.

Installatie

Verwarming
en koeling

Warmte- en
koudedistributie

Gereedschappen

Bijlage



Uponor Smatrix

Uponor temperatuurregelingen voor individuele ruimten oppervlakteverwarming/-koeling in de woningbouw

verwarmen en koelen		alleen verwarmen		
met automatische afstelling		met automatische afstelling	zonder automatische afstelling	
draadloos	bedraad	draadloos	bedraad	bedraad
Uponor Smatrix Wave PULSE	Uponor Smatrix Base PULSE	Uponor Smatrix Wave PULSE	Uponor Smatrix Base PULSE	Uponor Base met Flexiboard

De Uponor temperatuurregeling	... is een:
Uponor Smatrix Wave PULSE	per app aangestuurde draadloze temperatuurregeling voor individuele ruimten om te verwarmen en te koelen met vele functies, bijv. verbinding met Smart Home (<i>Amazon Alexa, Google Home</i>) en Cloud
Uponor Smatrix Wave	draadloze ruimtetemperatuurregeling voor oppervlakteverwarming en -koeling
Uponor Smatrix Base PULSE	per app aangestuurde bedrade temperatuurregeling voor individuele ruimten om te verwarmen en te koelen met vele functies, bijv. verbinding met Smart Home (<i>Amazon Alexa, Google Home</i>) en Cloud
Uponor Smatrix Base PRO	bedrade temperatuurregeling voor individuele ruimten om te verwarmen en te koelen met een maximum van 16 regelmodules voor commerciële gebouwen en grote objecten
Uponor Base	conventionele bedrade 230 V temperatuurregeling voor individuele ruimten voor een gemakkelijkeruimtetemperatuurregeling
Uponor Space	gemakkelijk te bedienen ruimtetemperatuurregeling voor koelplafonds met dauwpuntbewaking
Uponor Smatrix Style	design-ruimtesensor met vochtigheidsbewaking voor Smatrix Wave/Base PULSE en Smatrix Base PRO temperatuurregeling voor individuele ruimten
Smatrix Move	weersafhankelijke aanvoertemperatuurregelaar om te verwarmen en te koelen
Smatrix Move PRO	weersafhankelijke meerzonen-aanvoertemperatuurregelaar voor commerciële gebouwen om te verwarmen of te verwarmen/koelen en met bijkomend sneeuw- en ijsvrijhouden

Overzicht van de functies van Smatrix Wave/Base

Uponor Smatrix Regelingstechniek	complete versie		zonder Cloud		alleen regelmodule	
	 +  +  + 	 + 	 +  + 	 + 		
	Smatrix Wave PULSE	Smatrix Base PULSE	Smatrix Wave PULSE	Smatrix Base PULSE	Smatrix Wave PULSE	Smatrix Base PULSE
Toegang op afstand	■	■				
Comfortinstelling	■	■				
Verlagingsprogramma's	■	■				
Updates per app	■	■				
Verbinding Alexa	■	■				
Schakelen op afstand van andere installatiecomponenten via relaismodule	■					
Plaatselijke toegang via WLAN	■	■	■	■		
Maximum-/minimumbegrenzing van de voor-ingestelde temperatuur	■	■	■	■		
Aanmaken van een regelingsgroep met 4 regelmodules	■	■	■	■		
Uitgebreide omschakelmogelijkheden verwarmen/koelen	■	■	■	■		
Centrale verlagingsmodus	■	■	■	■		
Automatische afstelling	■	■	■	■	■	■
Verwarmen en koelen	■	■	■	■	■	■
RF-schakelaarstrip		■		■		■
Regeling van verwarmingselementen	■	■	■	■	■	■

Installatie

Verwarming en koeling

Warmte- en koudedistributie

Gereedschappen

Bijlage

Uponor Smatrix Wave / Pulse

art.nr.	omschrijving	LE	VPE	eenheid
---------	--------------	----	-----	---------

Uponor Smatrix Wave startset Pulse S

 1093284		3	1	set
---	--	---	---	-----

Uponor Smatrix Wave startset Pulse L

 1093287		2	1	set
---	--	---	---	-----

Uponor Smatrix Interface Pulse com R-208

 1093030		16	1	st.
---	--	----	---	-----

Uponor Smatrix Wave regelmodule Pulse X-265 6X

 1093021		4	1	st.
---	--	---	---	-----

Uponor Smatrix Wave slave module Pulse M-262 6X

 1093133		16	1	st.
--	--	----	---	-----

Uponor Smatrix Wave antenne Pulse A-265

 1093028		16	1	st.
---	--	----	---	-----

Uponor Smatrix Wave schakelmodule M-161

 1071673	2X	16	1	st.
---	----	----	---	-----

Uponor Smatrix Wave ruimtethermostaat met luchtvochtigheidssensor Style T-169

 1087816		180	1	st.
1087817	BLACK	180	1	st.

Uponor Smatrix Wave ruimtetemperatuursensor met luchtvochtigheidssensor Style T-161

 1087815		180	1	st.
---	--	-----	---	-----

art.nr.	omschrijving	LE	VPE	eenheid
---------	--------------	----	-----	---------

Uponor Smatrix Wave ruimtethermostaat prog.+RH T-168

 1086984	RAL9016	75	1	st.
---	---------	----	---	-----

Uponor Smatrix Wave ruimtethermostaat digit. T-166

 1086982	RAL9016	75	1	st.
---	---------	----	---	-----

Uponor Smatrix Wave ruimtethermostaat T-165 POD

 1086981	RAL9016	75	1	st.
---	---------	----	---	-----

Uponor Smatrix Wave ruimtethermostaat BM T-163

 1086979	RAL9016	75	1	st.
---	---------	----	---	-----

Uponor Smatrix Wave thermostaatknop T-162

 1071660		16	1	st.
---	--	----	---	-----

Uponor Smatrix montageplaat T-X A-1XX

 1086986	RAL9016	250	1	st.
---	---------	-----	---	-----

Uponor Smatrix vloer- en afstandsvoeiler S-1XX

 1071684		63	1	st.
---	--	----	---	-----

Uponor Smatrix schakelmodule H/K M-1XX

 1083576	24V	84	1	st.
---	-----	----	---	-----

Uponor Smatrix schakelmodule H/K M-1XX

 1083577	230V	16	1	st.
---	------	----	---	-----

Uponor Smatrix thermische aandrijving Retrofit set A-XXX

 1083575	24V, NC, 1W	100	1	set
---	-------------	-----	---	-----

Uponor Smatrix Base / Pulse

art.nr.	omschrijving	LE	VPE	eenheid
---------	--------------	----	-----	---------

Uponor Smatrix Base startset Pulse S

	1093280	3	1	set
---	---------	---	---	-----

Uponor Smatrix Base startset Pulse L

	1093282	2	1	set
---	---------	---	---	-----

Uponor Smatrix Interface Pulse com R-208

	1093030	16	1	st.
---	---------	----	---	-----

Uponor Smatrix Base regelmodule Pulse X-245 BUS 6X

	1093017	4	1	st.
---	---------	---	---	-----

Uponor Smatrix Base uitbreidingsmodule Pulse M-242 BUS 6X

	1093134	16	1	st.
--	---------	----	---	-----

Uponor Smatrix Base ster-module Pulse M-243 BUS 6X

	1093135	16	1	st.
---	---------	----	---	-----

Uponor Smatrix Base ruimtetemperatuur-vochtsensor Style T-149 Bus

	1087813	180	1	st.
	1087814 BLACK	180	1	st.

Uponor Smatrix Base PRO Vochtsensor ruimtetemperatuur Style T-141 Bus

	1087812 FLUSH	180	1	st.
---	---------------	-----	---	-----

Uponor Smatrix Base ruimtethermostaat prog +RH T-148 Bus

	1086977 RAL9016	75	1	st.
---	-----------------	----	---	-----

Uponor Smatrix Base ruimtethermostaat digit. T-146 Bus

	1086976 RAL9016	75	1	st.
---	-----------------	----	---	-----

art.nr.	omschrijving	LE	VPE	eenheid
---------	--------------	----	-----	---------

Uponor Smatrix Base ruimtethermostaat T-145 Bus POD

	1086975 RAL9016	75	1	st.
---	-----------------	----	---	-----

Uponor Smatrix Base ruimtethermostaat inbouw T-144 Bus

	1086973 RAL9016	60	1	st.
---	-----------------	----	---	-----

Uponor Smatrix Base ruimtethermostaat BM T-143 Bus

	1086972 RAL9016	75	1	st.
---	-----------------	----	---	-----

Uponor Smatrix vloer- en afstandsvoeler S-1XX

	1071684	63	1	st.
---	---------	----	---	-----

Uponor Smatrix Base opbouwmontageframe Style T-149 A-14X

	1087821	90	1	st.
	1087822 BLACK	90	1	st.

Uponor Smatrix montageplaat T-X A-1XX

	1086986 RAL9016	250	1	st.
---	-----------------	-----	---	-----

Uponor Smatrix Base Buskabel A-145

	1071670 50m	2	1	st.
---	-------------	---	---	-----

Uponor Smatrix schakelmodule H/K M-1XX

	1083576 24V	84	1	st.
---	-------------	----	---	-----

Uponor Smatrix schakelmodule H/K M-1XX

	1083577 230V	16	1	st.
---	--------------	----	---	-----

Uponor Smatrix thermische aandrijving Retrofit set A-XXX

	1083575 24V, NC, 1W	100	1	set
---	---------------------	-----	---	-----

Installatie





Verwarming en koeling

Warmte- en koudedistributie

Gereedschappen

Bijlage

Uponor Base

art.nr.	omschrijving	LE	VPE	eenheid
Uponor Base 6-kanaals regelmodule X-23				
 1058426	6X 230V	200	1	st.
Uponor Base flexiboard X-24				
 1088331	6X 230V	-	1	st.
Uponor Base flexiboard met pomplogica X-25				
 1089086	6X 230V	-	1	st.
Uponor Base flexiboard X-26				
 1089087	8X 230V	-	1	st.
Uponor Base flexiboard met pomplogica X-27				
 1089088	8X 230V	-	1	st.

art.nr.	omschrijving	LE	VPE	eenheid
Uponor Base ruimtethermostaat T-23				
 1058422	230V RAL9010	160	1	st.
Uponor Base ruimtethermostaat UP T-24				
 1058423	230V	-	1	st.
Uponor Base ruimtethermostaat V/K T-25				
 1058424	230V	-	1	st.
Uponor Base ruimtethermostaat prog. T-26				
 1058425	230V RAL9010	-	1	st.
Uponor Base afstandsvoeler				
 1047459	230V	-	1	st.
Uponor Vario B thermische aandrijving NC				
 1022244	230V FT28x1,5	10	1	st.
Uponor Vario thermische aandrijving NL NC				
 1020261	230V FT30x1,5	100	1	st.
Uponor Vario PLUS thermische aandrijving NC				
 1005605	230V MT30x1,5	10	1	st.

Uponor Smatrix Base PRO

art.nr.	omschrijving	LE	VPE	eenheid
---------	--------------	----	-----	---------

Uponor Smatrix Base PRO regelmodule X-147 Bus

 1087162	6X	4	1	st.
--	----	---	---	-----

Uponor Smatrix Base PRO Bedieningsmodule I-147 Bus

 1087161		7	1	st.
--	--	---	---	-----

Uponor Smatrix Base uitbreidingsmodule M-140 Bus

 1071686	6X	16	1	st.
--	----	----	---	-----

Uponor Smatrix Base ster-module M-141 Bus

 1071651	8X	16	1	st.
--	----	----	---	-----

art.nr.	omschrijving	LE	VPE	eenheid
---------	--------------	----	-----	---------

Uponor Smatrix Base PRO Vochtsensor ruimtetemperatuur Style T-141 Bus

 1087812	FLUSH	180	1	st.
--	-------	-----	---	-----

Uponor Vario

art.nr.	omschrijving	LE	VPE	eenheid
---------	--------------	----	-----	---------

Uponor Vario PLUS thermische aandrijving NC

 1000138	24V MT30x1,5	10	1	st.
1005605	230V MT30x1,5	10	1	st.

Uponor Vario B thermische aandrijving NC

 1007249	24V FT28x1,5	10	1	st.
1022244	230V FT28x1,5	10	1	st.

Uponor Vario PLUS elektrothermische aandrijving 100kOhm

 1005544	24V NC MT30x1,5 0-10V DC	100	1	st.
--	-----------------------------	-----	---	-----

art.nr.	omschrijving	LE	VPE	eenheid
---------	--------------	----	-----	---------

Uponor Vario aanvoer fijninregelafsluiter

 1005107	½" - G¾	50	1	st.
--	---------	----	---	-----

Uponor Vario retour fijninregelafsluiter

 1005108	½" - G¾	50	1	st.
--	---------	----	---	-----

Uponor Vario verdeler-inregelventiel

 1005100	G1 - Rp1	10	1	set
--	----------	----	---	-----

Regeling van de aanvoertemperatuur

art.nr.	omschrijving	LE	VPE	een- heid
---------	--------------	----	-----	--------------

Uponor Smatrix Move PRO

Uponor Smatrix Move PRO regelaar X-159

	1087155	10	1	st.
---	---------	----	---	-----

Uponor Smatrix Move PRO sneeuw- en ijsvrij houden S-152 + S-158

	1087158	-	1	set
	1087156	5	1	st.

Uponor Smatrix Move PRO ruimtesensor S-155

	1087159	10	1	st.
---	---------	----	---	-----

art.nr.	omschrijving	LE	VPE	een- heid
---------	--------------	----	-----	--------------

Uponor Smatrix Move PRO luchtvochtigheidssensor S-157

	1087160	75	1	st.
---	---------	----	---	-----

Uponor Smatrix Move PRO condensatieset S-159

	1087165	10	1	set
---	---------	----	---	-----

Uponor Smatrix Move

Uponor Smatrix Move regelaar X-157 Wired

	1071693	4	1	set
---	---------	---	---	-----

Uponor Smatrix Move aanvoer/retourvoeler S-152

	1071661	3m	63	1	st.
---	---------	----	----	---	-----

Uponor Smatrix buitenvoeler S-1XX

	1071671	45	1	st.
---	---------	----	---	-----

Uponor Smatrix schakelmodule H/K M-1XX

	1083577	230V	16	1	st.
---	---------	------	----	---	-----

Uponor Smatrix Move mengventiel motoraandrijving 230V

	1002357	-	1	st.
---	---------	---	---	-----

Regeling van de aanvoertemperatuur

art.nr.	omschrijving	LE	VPE	eenheid
---------	--------------	----	-----	---------

Uponor Fluvia

Uponor Fluvia T regelaar Push-12-CH-X

 1085982		50	1	st.
---	--	----	---	-----

Uponor Fluvia T pompgroep Push-12 AC-G

 1095128		60	1	st.
---	--	----	---	-----

Uponor Fluvia schroef-Y-stuk

 1005675	2xG $\frac{3}{4}$ - $\frac{3}{4}$ "Euro	50	1	set
---	---	----	---	-----

Uponor Vario vul- en aftapkraan

 1061802	$\frac{3}{4}$ " - $\frac{3}{4}$ "	10	1	set
---	-----------------------------------	----	---	-----

Uponor Aqua PLUS verdelerkap met vlakdichting

 1001337	$\frac{3}{4}$ "FT	250	10	st.
---	-------------------	-----	----	-----

Uponor Fluvia Move pompgroep Push-23-A-AC

 1085008		30	1	st.
---	--	----	---	-----

Uponor Fluvia T pompgroep Push-23-B-W

 1078304		55	1	st.
---	--	----	---	-----

Uponor Fluvia Move pompgroep MPG-10-A-W

 1078306		30	1	st.
---	--	----	---	-----

Uponor Fluvia pompgroep MPG-10-B-W

 1078307		30	1	st.
---	--	----	---	-----

art.nr.	omschrijving	LE	VPE	eenheid
---------	--------------	----	-----	---------

Uponor Vario aansluitstuk

 1058573	G1-G1A	30	1	st.
---	--------	----	---	-----

Uponor Fluvia maximaalthermostaat

 1005504	5-60	10	1	st.
---	------	----	---	-----

Uponor Fluvia Move pompgroep PPG-30-A-W

 1084143		22	1	st.
---	--	----	---	-----

Uponor Smatrix Move mengventiel motoraandrijving pro

 1002356	A-15X 24V 0-10 V	-	1	st.
---	------------------	---	---	-----

Uponor Smatrix Move mengventiel motoraandrijving 230V

 1002357		-	1	st.
---	--	---	---	-----

Installatie

Verwarming
en koeling

Warmte- en
koudedistributie

Gereedschappen

Bijlage

Verbindingstechniek, fittingen en gereedschappen voor Uponor Ecoflex leidingen

Type	Afmeting [mm]	Medium- buis	Isolatiemateriaal	Mantel- buis	Temperatuur / Druk	Lengte [m]	Artikelnr.	Certificering
VIP Thermo Single	40 x 3,7/140	PE-Xa + EVOH	VIP + PEX-schuim	PE-HD	max. 95 °C / 6 bar	200	1095714	CSTB systeem-certificering
	50 x 4,6/140					200	1095715	
	63 x 5,8/140					200	1095716	
	75 x 6,8/140					200	1095717	
	90 x 8,2/175					100	1095718	
	110 x 10,0/175					100	1095719	
	125 x 11,4/200					120	1095720	
VIP Thermo Twin	2x25 x 2,3/140	PE-Xa + EVOH	VIP + PEX-schuim	PE-HD	max. 95 °C / 6 bar	200	1118580	CSTB systeem-certificering
	2x32 x 2,9/140					200	1118581	
	2x40 x 3,7/175					200	1118582	
	2x50 x 4,6/175					200	1118583	
	2x63 x 5,8/200					100	1118584	
	2x75 x 6,8/250					100	1118585	
Thermo Single <small>optioneel met verwarmingkabel</small>	25 x 2,3/140	PE-Xa + EVOH	PEX-schuim	PE-HD	max. 95 °C / 6 bar	200	1018109	KOMO systeem-certificering volgens BRL5609 CSTB systeem-certificering Gost
	32 x 2,9/140					200	1018110	
	40 x 3,7/175					200	1018111	
	50 x 4,6/175					200	1018112	
	63 x 5,8/175					200	1018113	
	75 x 6,8/200					100	1018114	
	90 x 8,2/200					100	1018115	
	110 x 10,0/200					100	1018116	
Thermo Twin	2x25 x 2,3/175	PE-Xa + EVOH	PEX-schuim	PE-HD	max. 95 °C / 6 bar	200	1018134	KOMO systeem-certificering volgens BRL5609 CSTB systeem-certificering Gost
	2x32 x 2,9/175					200	1018135	
	2x40 x 3,7/175					200	1018136	
	2x50 x 4,6/200					100	1018137	
	2x63 x 5,8/200					100	1018138	
Thermo Mini	25 x 2,3/68	PE-Xa + EVOH	PEX-schuim	PE-HD	max. 95 °C / 6 bar	200	1018132	STB systeem-certificering
	32 x 2,9/68					200	1018133	

VERWARMING EN KOELING

Verbindingstechniek en gereedschappen

Wipex overgangspuntstuk



Ecoflex overgangspuntstuk



Quick & Easy



Toebehoren

PN6 + grafietpasta + spreidtang + inbus



PN6 + grafietpasta + inbus



PN6 + grafietpasta + inbus



Expansiegereedschap M18 6 bar



M18 VLD



Ring natural



Ring wit



Rubberen eindkap

	PN6 + grafietpasta + spreidtang + inbus	PN6 + grafietpasta + inbus	PN6 + grafietpasta + inbus	Expansiegereedschap M18 6 bar	M18 VLD	Ring natural	Ring wit
	•			•	•	•	
	•				•	•	
		•			•	•	
		•			•	•	
		•			•	•	
		•	•		•	•	
	•			•	•	•	•
	•			•	•	•	•
	•			•	•	•	
	•			•	•	•	
	•			•	•	•	
	•			•	•	•	
	•			•	•	•	
	•			•	•	•	•
	•			•	•	•	•
	•			•	•	•	
	•			•	•	•	
	•			•	•	•	•
	•			•	•	•	•

Installatie

Verwarming en koeling

Warmte- en koudedistributie

Gereedschappen

Bijlage

Verbindingstechniek, fittingen en gereedschappen voor Uponor Ecoflex leidingen

Type	Afmeting [mm]	Medium-buis	Isolatie-materiaal	Mantel-buis	Temperatuur / Druk	Lengte [m]	Artikelnr.	Certificering	Toebehoren Rubberen eindkap
WARM DRINKWATER	VIP Aqua Single	40 x 5,5/140	PE-Xa	VIP + PEX-schuim	PE-HD	max. 95 °C / 10 bar	200	1119047	DVGW, ÖVGW
		50 x 6,9/140					200	1119048	
		63 x 8,6/140					200	1119049	
	VIP Aqua Twin	25 x 3,5-20 x 2,8/140	PE-Xa	VIP + PEX-schuim	PE-HD	max. 95 °C / 10 bar	200	1119053	DVGW, ÖVGW
		32 x 4,4-20 x 2,8/140					200	1119054	
		40 x 5,5-25 x 3,5/140					200	1119055	
		50 x 6,9-32 x 4,4/175					200	1119056	
	Aqua Single optioneel met verwarmingskabel	25 x 3,5/140	PE-Xa	PEX-schuim	PE-HD	max. 95 °C / 10 bar	200	1018117	DVGW, ÖVGW
		32 x 4,4/140					200	1018118	
40 x 5,5/175		200					1018119		
50 x 6,9/175		200					1018120		
63 x 8,6/175		200					1018121		
Aqua Twin	25 x 3,5-25 x 3,5/175	PE-Xa	PEX-schuim	PE-HD	max. 95 °C / 10 bar	200	1018139	DVGW, ÖVGW	
	32 x 4,4-25 x 3,5/175					200	1018140		
	40 x 5,5-25 x 3,5/175					200	1018141		
	50 x 6,9-25 x 3,5/175					200	1018142		
VERWARMEN EN WARM DRINKWATER	Quattro	2x25 x 2,3-2x25 x 3,5/175	PE-Xa + EVOH + PE-Xa	PEX-schuim	PE-HD	max. 95 °C / 6 / 10 bar	200	1018147	DVGW, ÖVGW
		2x32 x 2,9-2x25 x 3,5/175					200	1018148	
		2x32 x 2,9-32 x 4,4-25 x 3,5/175					200	1018149	
		2x40 x 3,7-32 x 4,4-20 x 2,8/200					100	1084891	
		2x40 x 3,7-40 x 5,5-25 x 3,5/200					100	1084890	
KOUDE DRINKWATER EN KOELEN	Supra	25 x 2,3/68	PE 100-RC zwart met blauwe laag	PEX-schuim	PE-HD	20 °C / 16 bar	200	1095722	DVGW
		32 x 2,9/68					200	1095723	
		40 x 3,7/140					200	1095724	
		50 x 4,6/140					200	1095725	
		63 x 5,8/140					200	1095726	
		75 x 6,8/175					100	1095727	
		90 x 8,2/175					100	1095728	
		110 x 10,0/200					100	1095729	
KOUDE DRINKWATER	Supra PLUS kabel met anti-vrieskabel	25 x 2,3/68	PE 100-RC zwart met blauwe laag	PEX-schuim	PE-HD	20 °C / 16 bar	150	1095730	DVGW
		32 x 2,9/68					150	1095731	
		40 x 3,7/140					150	1095734	
		50 x 4,6/140					150	1095736	
		63 x 5,8/140					150	1095737	
		75 x 6,8/175					150	1095738	
		90 x 8,2/200					100	1095739	
		110 x 10,0/200					100	1095740	

Ecoflex warmte- en koudedistributie

art.nr.	omschrijving	LE	VPE	een- heid
---------	--------------	----	-----	--------------

Uponor Ecoflex VIP Thermo

Uponor Ecoflex VIP Thermo Single

 1095714	40X3,7/140	-	200	m
1095715	50X4,6/140	-	200	m
1095716	63X5,8/140	-	200	m
1095717	75X6,8/140	-	200	m
1095718	90X8,2/175	-	150	m
1095719	110X10,0/175	-	150	m
1095720	125X11,4/200	-	120	m

Uponor Ecoflex VIP Thermo Twin

 1118580	2x25x2,3/140	-	200	m
1118581	2x32x2,9/140	-	200	m
1118582	2x40x3,7 /175	-	200	m
1118583	2x50x4,6/175	-	200	m
1118584	2x63x5,8/200	-	100	m
1118585	2x75x6,8/250	-	100	m

Uponor Ecoflex Thermo

Uponor Ecoflex Thermo Single

 1018109	25x2,3/140	-	200	m
1018110	32x2,9/140	-	200	m
1018111	40x3,7/175	-	200	m
1018112	50x4,6/175	-	200	m
1018113	63x5,8/175	-	200	m
1018114	75x6,8/200	-	100	m
1018115	90x8,2/200	-	100	m
1018116	110x10,0/200	-	100	m

Uponor Ecoflex Thermo Twin

 1018134	2x25x2,3/175	-	200	m
1018135	2x32x2,9/175	-	200	m
1018136	2x40x3,7 /175	-	200	m
1018137	2x50x4,6/200	-	100	m
1018138	2x63x5,8/200	-	100	m

Uponor Ecoflex Thermo Mini

 1018132	25x2,3/68	-	200	m
1018133	32x2,9/68	-	200	m
1095574	32x2,9/68 L=25m	50	25	m

art.nr.	omschrijving	LE	VPE	een- heid
---------	--------------	----	-----	--------------

Uponor Ecoflex VIP Aqua

Uponor Ecoflex VIP Aqua Single

 1119047	40x5,5/140	-	200	m
1119048	50x6,9/140	-	200	m
1119049	63x8,6/140	-	200	m

Uponor Ecoflex VIP Aqua Twin

 1119053	25x3,5-20x2,8/140	-	200	m
1119054	32x4,4-20x2,8/140	-	200	m
1119055	40x5,5-25x3,5/140	-	200	m
1119056	50x6,9-32x4,4/175	-	200	m

Uponor Ecoflex Aqua

Uponor Ecoflex Aqua Single

 1018117	25x3,5/140	-	200	m
1018118	32x4,4/140	-	200	m
1018119	40x5,5/175	-	200	m
1018120	50x6,9/175	-	200	m
1018121	63x8,6/175	-	200	m

Uponor Ecoflex Aqua Twin

 1018139	25x3,5-25x3,5/175	-	200	m
1018140	32x4,4-25x3,5/175	-	200	m
1018141	40x5,5-25x3,5/175	-	200	m
1018142	50x6,9-25x3,5/175	-	200	m

Ecoflex warmte- en koudedistributie

art.nr.	omschrijving	LE	VPE	eenheid
---------	--------------	----	-----	---------

Uponor Ecoflex Quattro

Uponor Ecoflex Quattro

 1018147	2x25x2,3-2x25x3,5/175	-	200	m
1018148	2x32x2,9-2x25x3,5/175	-	200	m
1018149	2x32x2,9-32x4,4-25x3,5/175	-	200	m

Uponor Ecoflex Supra

Uponor Ecoflex Supra

 1095722	25x2,3/68	-	200	m
1095723	32x2,9/68	-	200	m
1095724	40x3,7/140	-	200	m
1095725	50x4,6/140	-	200	m
1095726	63x5,8/140	-	200	m
1095727	75x6,8/175	-	150	m
1095728	90x8,2/175	-	100	m
1095729	110x10,0/200	-	100	m

art.nr.	omschrijving	LE	VPE	eenheid
---------	--------------	----	-----	---------

Uponor Ecoflex Supra PLUS

Uponor Ecoflex Supra PLUS cable

 1095730	25x2,3/68 1x10W/m	-	150	m
1095731	32x2,9/68 1x10W/m	-	150	m
1095734	40x3,7/140 1x10W/m	-	150	m
1095736	50x4,6/140 1x10W/m	-	150	m
1095737	63x5,8/140 1x10W/m	-	150	m
1095738	75x6,8/175 1x10W/m	-	150	m
1095739	90x8,2/200 1x10W/m	-	100	m
1095740	110x10,0/200 1x10W/m	-	100	m

Uponor Ecoflex Supra PLUS Set

 NEW 1120124	25+32/68	-	1	set
NEW 1120126	40+50+63/140	-	1	set
NEW 1120127	75/175	-	1	set
NEW 1120128	90+110/200	-	1	set

Uponor Ecoflex Supra PLUS Regelaar 150

 NEW 1120123		50	1	st.
---	--	----	---	-----

Uponor Ecoflex Supra PLUS kabelset S1

 1042310		-	1	st.
--	--	---	---	-----

Uponor Ecoflex Supra PLUS kabelset S2

 1042311		-	1	st.
--	--	---	---	-----

Uponor Ecoflex Supra PLUS T-set

 1061641	140/90/68	5	1	st.
1061642	200/175/140	3	1	st.

Uponor Ecoflex reduceerring

 1060991	200/68	8	1	st.
--	--------	---	---	-----

Uponor Wipex

art.nr.	omschrijving	LE	VPE	eenheid
Uponor Wipex overgangspuntstuk PN6				
 1018328	25x2,3-G1	40	1	st.
1018329	32x2,9-G1	20	1	st.
1018330	40x3,7-G1 ¼	10	1	st.
1018331	50x4,6-G1 ¼	10	1	st.
1018332	63x5,8-G2	8	1	st.
1018333	75x6,8-G2	6	1	st.
1018334	90x8,2-G3	4	1	st.
1018335	110x10,0-G3	3	1	st.

Uponor Ecoflex overgangspuntstuk PN6

 1078368	125x11,4-R4	-	1	st.
--	-------------	---	---	-----

Uponor Ecoflex overgangspuntstuk PN10

 1091505	20x2,8-¾"	10	1	st.
--	-----------	----	---	-----

Uponor Wipex overgangspuntstuk PN10

 1018336	25x3,5-G1	40	1	st.
1018338	32x4,4-G1	20	1	st.
1018339	40x5,5-G1 ¼	10	1	st.
1018340	50x6,9-G1 ¼	10	1	st.
1018341	63x8,6-G2	8	1	st.

Uponor Wipex koppeling PN6

 1042972	25x2,3-25x2,3	30	1	st.
1042973	32x2,9-32x2,9	25	1	st.
1042980	40x3,7-40x3,7	15	1	st.
1042984	50x4,6-50x4,6	10	1	st.
1042981	63x5,8-63x5,8	5	1	st.
1042985	75x6,8-75x6,8	3	1	st.
1042986	90x8,2-90x8,2	4	1	st.
1042987	110x10-110x10	2	1	st.

Uponor Ecoflex koppeling PN6

 1078365	125x11,4-125x11,4	-	1	st.
--	-------------------	---	---	-----

art.nr.	omschrijving	LE	VPE	eenheid
Uponor Wipex koppeling PN10				
 1042970	25x3,5-25x3,5	40	1	st.
1042974	32x4,4-32x4,4	25	1	st.
1042979	40x5,5-40x5,5	15	1	st.
1042983	50x6,9-50x6,9	10	1	st.
1042982	63x8,6-63x8,6	4	1	st.

Uponor Wipex T-stuk binnendraad

 1018345	G1-G1-G1	20	1	st.
1018346	G1 ¼-G1 ¼-G1 ¼	10	1	st.
1018347	G2-G2-G2	4	1	st.
1018348	G3-G3-G3	3	1	st.

Uponor Ecoflex T-stuk

 1078367	Rp4-Rp4-Rp4	-	1	st.
--	-------------	---	---	-----

Uponor Wipex knie binnendraad

 1018350	G1-G1	20	1	st.
1018351	G1 ¼-G1 ¼	15	1	st.
1018352	G2-G2	5	1	st.
1018353	G3-G3	2	1	st.

Uponor Ecoflex knie

 1078366	Rp4-Rp4	-	1	st.
--	---------	---	---	-----

Uponor Wipex draadsok binnendraad

 1018355	G1-G1	40	1	st.
1018356	G1 ¼-G1 ¼	25	1	st.
1018357	G2-G2	15	1	st.
1018358	G3-G3	10	1	st.

Uponor Wipex

art.nr.	omschrijving	LE	VPE	eenheid
Uponor Wipex reductie bu.dr./bi.dr.				
 1018368	G1 1/4-G1	25	1	st.
1018369	G1 1/2-G1 1/4	25	1	st.
1018371	G2-G1	15	1	st.
1018372	G2-G1 1/4	15	1	st.
1018373	G2 1/2-G2	6	1	st.
1018374	G3-G1	6	1	st.
1018375	G3-G1 1/4	10	1	st.
1018376	G3-G2	10	1	st.
1009052	G4-G3	6	1	st.

Uponor Ecoflex reductie bu.dr./bi.dr.

 1078369	R4-G3	6	1	st.
--	-------	---	---	-----

Uponor Wipex draadflens binnendraad

 1018359	F25/4-85/G1	10	1	st.
1018360	F32/4-100/G1 1/4	5	1	st.
1018361	F40/4-110/G1 1/2	5	1	st.
1018362	F50/4-125/G2	4	1	st.
1018363	F65/8-145/2 1/2	3	1	st.
1018364	F80/8-160/G3	3	1	st.
1018365	F100/8-180/G4	3	1	st.

Uponor Ecoflex draadflens binnendraad

 1078370	F100/8-180/Rp4	-	1	st.
--	----------------	---	---	-----

Uponor Wipex draadnippel buitendraad

 1045455	G1	20	1	st.
1045456	G1 1/4-G1	20	1	st.
1045457	G1 1/4	15	1	st.
1065442	G1 1/4 120mm	8	1	st.
1045458	G2-G1 1/4	10	1	st.
1045459	G2	10	1	st.
1065444	G2 120mm	3	1	st.
1045460	G3-G2	3	1	st.
1045461	G3	2	1	st.

art.nr.	omschrijving	LE	VPE	eenheid
Uponor Wipex fixpuntsok bu.dr./bi.dr.				
 1018302	G1	30	1	st.
1018303	G1 1/4	10	1	st.
1018304	G2	5	1	st.
1018305	G3	5	1	st.

Uponor Ecoflex Aanlaskoppeling ST PN6 EU+GOST

 1094013	25x2,3-26,9	-	1	st.
1094014	32x2,9-33,7	-	1	st.
1094015	40x3,7-42,4	-	1	st.
1094016	50x4,6-48,3	-	1	st.
1094017	63x5,8-60,3	-	1	st.
1094018	75x6,8-76,1	-	1	st.
1094019	90x8,2-88,9	-	1	st.
1094020	110x10,0-114,3	-	1	st.
1094021	125x11,4-114,3	-	1	st.

Uponor Wipex MLC perskoppeling S-Press PN6

 1060058	32x2,9-32x3,0	25	1	st.
---	---------------	----	---	-----

Uponor Wipex MLC perskoppeling S-Press PN6

 1060059	40x3,7-40x4,0	15	1	st.
1060060	50x4,6-50x4,5	10	1	st.

Uponor Wipex spreidtang

 1046407	1 - 1 1/2	25	1	st.
--	-----------	----	---	-----

Uponor Q&E

art.nr.	omschrijving	LE	VPE	eenheid
---------	--------------	----	-----	---------

Uponor Q&E zekeringsring white

	1057455 25	300	20	st.
	1057456 32	150	10	st.

Uponor Q&E ring met stop-edge natural

	1045464 40	80	5	st.
	1045489 50	70	5	st.
	1045490 63	35	5	st.
	1085087 75	18	2	st.

Uponor Q&E knie 90° PPSU

	1008681 25-25	25	5	st.
	1001245 32-32	10	1	st.
	1008683 40-40	10	1	st.
	1042859 50-50	5	1	st.
	1042858 63-63	3	1	st.
	1085080 75-75	2	1	st.

Uponor Q&E koppeling PPSU

	1008671 25-25	50	5	st.
	1001235 32-32	15	1	st.
	1008673 40-40	10	1	st.
	1042866 50-50	10	1	st.
	1042865 63-63	5	1	st.
	1085084 75-75	10	1	st.

Uponor Q&E koppeling verlopend PPSU

	1001240 32-25	20	1	st.
	1008678 40-32	10	1	st.
	1042879 50-32	10	1	st.
	1042867 50-40	10	1	st.
	1042878 63-40	5	1	st.
	1042877 63-50	5	1	st.
	1085086 75-50	10	1	st.
	1085085 75-63	10	1	st.

Uponor Q&E T-stuk PPSU

	1008686 25-25-25	20	5	st.
	1001250 32-32-32	10	1	st.
	1008688 40-40-40	5	1	st.
	1042861 50-50-50	3	1	st.
	1042860 63-63-63	2	1	st.
	1085081 75-75-75	2	1	st.

art.nr.	omschrijving	LE	VPE	eenheid
---------	--------------	----	-----	---------

Uponor Q&E T-stuk verlopend PPSU

	1008712 25-32-25	15	1	st.
	1001426 32-25-25	15	1	st.
	1001428 32-25-32	15	1	st.
	1008713 32-40-32	10	1	st.
	1008708 40-25-32	5	1	st.
	1008695 40-25-40	5	1	st.
	1008709 40-32-32	5	1	st.
	1008696 40-32-40	5	1	st.
	1042876 50-25-40	4	1	st.
	1042864 50-25-50	4	1	st.
	1042863 50-32-50	4	1	st.
	1042862 50-40-40	4	1	st.
	1042875 50-40-50	4	1	st.
	1042871 63-25-50	2	1	st.
	1042873 63-25-63	2	1	st.
	1042870 63-32-63	2	1	st.
	1042869 63-40-40	2	1	st.
	1042872 63-40-63	2	1	st.
	1042868 63-50-50	2	1	st.
	1042874 63-50-63	2	1	st.
	1085083 75-25-75	4	1	st.
	1085082 75-40-75	4	1	st.

Uponor Q&E puntstuk PL

	1023007 25-R $\frac{3}{4}$ "MT	70	5	st.
	1047191 32-R1"MT	10	1	st.

Uponor Q&E reduceernippel PL/DR

	1085077 40-R1 $\frac{1}{4}$ "MT	16	1	st.
	1085076 50-R1 $\frac{1}{2}$ "MT	8	1	st.
	1085075 63-R2"MT	6	1	st.
	1085074 75-R2 $\frac{1}{2}$ "MT	6	1	st.

Uponor Q&E knie binnendraad PL

	1023026 25-G $\frac{3}{4}$ "FT	35	5	st.
---	---------------------------------------	----	---	-----

Uponor Q&E schroefbus PL

	1023012 25-Rp $\frac{3}{4}$ "FT	40	5	st.
---	--	----	---	-----

Uponor Ecoflex systeemtoebehoren

art.nr.	omschrijving	LE	VPE	eenheid
Uponor Ecoflex rubberen eindkap Single				
 1018316	25+32+40/68	-	1	st.
1018315	25+28+32/140	-	1	st.
1018313	32+40+50/175	-	1	st.
1018314	40+50+63/140	-	1	st.
1095801	63+75+90/140	-	1	st.
1018312	63+75/175	-	1	st.
1018310	75+90+110/200	-	1	st.
1018311	90+110/175	-	1	st.
1067757	125/200	-	1	st.

Uponor Ecoflex rubberen eindkap Twin				
 1119374	18-22+25-28+32/140	-	1	st.
1018245	25+32+40/140	-	1	st.
1018309	25+32+40/175	-	1	st.
1018308	25+32+50/175	-	1	st.
1018307	40+50+63/200	-	1	st.
1088979	75+90/250	-	1	st.

Uponor Ecoflex rubberen eindkap Quattro				
 1086838	20+25+32/140	-	1	st.
1018306	18-32+25-32/175	-	1	st.
1094252	25+32+40/175	-	1	st.
1034308	18-28+32+40/200	-	1	st.

Uponor Ecoflex isolatieset T-stuk				
 1060986	140/90/68	5	1	st.
1060982	200/175/140	4	1	st.

Uponor Ecoflex isolatieset haaks				
 1060985	200/175/140	3	1	st.

Uponor Ecoflex isolatieset recht				
 1060984	200/175/140	6	1	st.

art.nr.	omschrijving	LE	VPE	eenheid
Uponor Ecoflex reduceerring				
 1060991	200/68	8	1	st.
NEW 1085107	200/160	12	1	st.

Uponor Ecoflex mantelbuisverbindingset				
 1084574	175+200	10	1	st.
1083872	250	9	1	st.

Uponor Ecoflex H-isolatieset				
 1007355	200/175/140	-	1	st.

Uponor Ecoflex inspectieput				
 1018326	6x140/145/175/200	-	3	st.
1018327	8x140/145/175/200	-	3	st.

Uponor Ecoflex tape inspectieput				
 1018382	50mm x 10m	-	1	st.

Uponor Ecoflex krimp slang inspectieput				
 1018379	140	-	1	st.
1018380	175/200	-	1	st.

Uponor Ecoflex huisaansluiting haaks Single				
 1118767	75x6,8/140	-	1	st.
Levertijd op aanvraag				

Uponor Ecoflex huisaansluiting haaks Twin				
 1118771	2x25x2,3/140	-	1	st.
1118772	2x32x2,9/140	-	1	st.
1118773	2x40x3,7/160	-	1	st.
1118774	2x50x4,6/200	-	1	st.
1118775	2x63x5,8/200	-	1	st.
1118776	2x75x6,8/250	-	1	st.
Levertijd op aanvraag.				

Installatie

Verwarming
en koeling

Warmte- en
koudedistributie

Gereedschappen

Bijlage

Uponor Ecoflex systeemtoebehoren

art.nr.	omschrijving	LE	VPE	eenheid
Uponor Ecoflex muurdoorvoering DWD				
 1007358	68	-	1	st.
1007360	140	-	1	st.
1007361	175	-	1	st.
1007362	200	-	1	st.
1091429	250	-	1	st.

Uponor Ecoflex verst.muurdoorvoering DWD

 1007365	140	-	1	st.
1007366	175	-	1	st.
1007367	200	-	1	st.
1091430	250	-	1	st.

Uponor Ecoflex vezelcementbuis DWD

 1007368	68	-	1	st.
1007370	140	-	1	st.
1007371	175	-	1	st.
1007372	200	-	1	st.

Uponor Ecoflex epoxyharsset DWD

 1007373	1,1 kg/3,5m ²	-	1	set
---	--------------------------	---	---	-----

Uponor Ecoflex muurdoorvoering NWD

 1018267	68+90	-	1	st.
1018269	140	-	1	st.
1018268	175+200	-	1	st.
1083871	250	16	1	st.

Uponor Ecoflex labyrint afdichting NDW

 1034202	140	40	1	st.
1034203	175	30	1	st.
1034204	200	20	1	st.
1090415	250	-	1	st.

Uponor Ecoflex krimpmanchet

 1036014	140+175+200-700mm	-	1	st.
---	-------------------	---	---	-----

art.nr.	omschrijving	LE	VPE	eenheid
Uponor Ecoflex krimpband				
 1093120	160mm x 10m	30	1	st.

Uponor Ecoflex markeringstape rood

 1018385	40mm x 250m	-	1	st.
1105785	40mm x 30m	-	1	st.

Uponor Multi buissnijder

 1089677	32-40	12	1	st.
1089779	32-40 verv.mes*	50	1	st.

Uponor Flex buissnijder PEX

 1095265	50-63	12	1	st.
1095266	50+63 verv.mes*	50	1	st.

Uponor Multi buissnijder

 1089675	25-63	12	1	st.
1089777	25-63 verv.mes*	50	1	st.

Uponor Multi buissnijder

 1089676	50-125	8	1	st.
1089778	50-125 verv.mes*	50	1	st.

Uponor MLC universele ontbramer 40-110 mm

 1060167		50	1	st.
---	--	----	---	-----

Uponor Wipex spreidtang

 1046407	1 - 1 ½	25	1	st.
---	---------	----	---	-----

Uponor Q&E grafietpasta

 1005017	100g	-	1	st.
---	------	---	---	-----

Uponor Ecoflex afdichtingskit

 1060996	290ml	-	1	st.
---	-------	---	---	-----

Uponor Ecoflex schroevenset

 1060995	M6x30 (34pcs)	-	1	st.
---	---------------	---	---	-----

* = vervangingsmes / - snijwiel

Gereedschappen

art.nr.	omschrijving	LE	VPE	een- heid
---------	--------------	----	-----	--------------

Verleggen

Uponor MLC leidinguitlijner



1010512	14-25	60	1	st.
---------	-------	----	---	-----

Uponor Multi telescoop leidinghaspel



1058662		-	1	st.
---------	--	---	---	-----

Uponor Multi leidinghaspel



1006255	120-960M	-	1	st.
---------	----------	---	---	-----

Uponor Magna leidinghaspel



1006256	25-640m	-	1	st.
---------	---------	---	---	-----

Uponor Wipex spreidtang



1046407	1 - 1 ½	25	1	st.
---------	---------	----	---	-----

Vorbereiden, snijden, buigen

Uponor Multi buis en mantelbuissnijder



1089674	12-25	36	1	st.
1089776	12-25	150	1	st.

Uponor Multi buissnijder



1089677	32-40	12	1	st.
1089779	32-40 verv.mes*	50	1	st.

Uponor Flex buissnijder PEX



1095265	50-63	12	1	st.
1095266	50+63 verv.mes*	50	1	st.

Uponor Multi buissnijder



1089675	25-63	12	1	st.
1089777	25-63 verv.mes*	50	1	st.

Uponor Multi buissnijder



1089676	50-125	8	1	st.
1089778	50-125 verv.mes*	50	1	st.

Uponor Flex buissnijder PEX



1089673	12-25	36	1	st.
1089780	12-25 verv.mes*	150	1	st.

Uponor MLC vervangingsnijwiel



1006635	25-63	1000	1	st.
1014173	50-110	20	1	st.

Uponor MLC buissnijder- en ontbraamset



1014334	63-110	32	1	st.
1014320	63-110 verv.mes*	100	1	st.

* = vervangingsmes / - snijwiel

Installatie

Verwarming
en koeling

Warmte- en
koudedistributie

Gereedschappen

Bijlage

Gereedschappen

art.nr.	omschrijving	LE	VPE	een- heid
---------	--------------	----	-----	--------------

Vorbereiden, snijden, buigen

Uponor MLC ontbramer

	1006952	14	50	1	st.
	1006830	16	50	1	st.
	1015749	20	1200	1	st.
	1015756	25	960	1	st.
	1015762	32	900	1	st.

Uponor MLC ontbramer

	1006638	40	600	1	st.
	1015808	50	600	1	st.
	1014339	63	600	1	st.
	1014344	75	600	1	st.

Uponor MLC combi-ontbramer

	1015739	16/20/25	60	1	st.
---	---------	----------	----	---	-----

Uponor MLC universele ontbramer 40-110 mm

	1060167		50	1	st.
---	---------	--	----	---	-----

Uponor MLC binnen-buigveer

	1013727	14	1000	1	st.
	1013729	16	100	1	st.
	1013734	20	75	1	st.
	1013737	25	50	1	st.
	1013739	32	40	1	st.

Uponor MLC buiten-buigveer

	1006639	14	550	1	st.
	1006640	16	55	1	st.
	1013792	20	45	1	st.
	1013794	25	45	1	st.

art.nr.	omschrijving	LE	VPE	een- heid
---------	--------------	----	-----	--------------

Uponor Uni Pipe PLUS buig gereedschap

	1071925	16-32	100	1	st.
---	---------	-------	-----	---	-----

Uponor Uni Pipe PLUS buigsegment

	NEW 1120408	R32 16	10	1	st.
	NEW 1120409	R40 20	10	1	st.
	NEW 1120410	R62,5 25	10	1	st.
	NEW 1120411	R80 32	10	1	st.

Uponor MLC buigtang

	OUT 1013773	16-32	48	1	st.
---	--------------------	-------	----	---	-----

OUT Artikel is uitlopend.
Levering zolang de voorraad strekt.

Uponor RTM combi kalibreer

	1048606	16/20/25	20	1	st.
--	---------	----------	----	---	-----

Persen

art.nr.	omschrijving	LE	VPE	eenheid
---------	--------------	----	-----	---------

Uponor S-Press accu-gereedschapspakket BENELUX

 1083584	16/20/25	10	1	set
1083585	16/20/25/32	10	1	set
netto installateur				

Uponor S-Press accu persmachine UP110 zonder persbekken

 1083612		20	1	set
--	--	----	---	-----

Uponor S-Press reserve accu UP110

 1083608		10	1	st.
--	--	----	---	-----

Uponor S-Press reserve acculader

 1083610	Mini2, UP110	72	1	st.
--	--------------	----	---	-----

Uponor S-Press elek.persmachine z.persbek UP75

 1007082		20	1	st.
---	--	----	---	-----

Uponor S-Press persbek UPP1

 1007083	14	280	1	st.
1007084	16	216	1	st.
1007086	20	-	1	st.
1007087	25	-	1	st.
1007088	32	-	1	st.

Uponor S-Press persbek UPP1

 1015768	40	108	1	st.
1015792	50	108	1	st.

Uponor S-Press basispersbek

 1046545	63-110	-	1	st.
--	--------	---	---	-----

Uponor S-Press persketting

 1046541	63	72	1	st.
1046542	75	72	1	st.
1046543	90	72	1	st.
1046544	110	54	1	st.

art.nr.	omschrijving	LE	VPE	eenheid
---------	--------------	----	-----	---------

Uponor S-Press accupersmachine Mini2 met Mini KSP0 persbek

 1083586	16/20/25/32	30	1	set
netto installateur				

Uponor S-Press accupersmachine Mini2 met Mini KSP0 persbek

 1083594	16/20/25	25	1	set
netto installateur				

Uponor S-Press persbek Mini2 KSP0

 1007090	14	5	1	st.
1007091	16	5	1	st.
1007093	20	5	1	st.
1007094	25	5	1	st.
1007095	32	5	1	st.
netto installateur				

Uponor S-Press reserve accu Mini2

 1083605		48	1	st.
netto installateur				

Uponor S-Press reserve acculader

 1083610	Mini2, UP110	72	1	st.
--	--------------	----	---	-----

Uponor S-Press handperstang inzetbek

 1015764	14-20	100	1	st.
<i>LET OP! Niet geschikt voor monteren en persen van het Uponor GAS Press systeem</i>				

Uponor S-Press inzetbek handperstang

 1015776	14	400	1	st.
1015777	16	50	1	st.
1015780	20	50	1	st.
<i>LET OP! Niet geschikt voor monteren en persen van het Uponor GAS Press systeem</i>				

Uponor S-Press handperstangset BENELUX

 1013778	14-20	20	1	st.
netto installateur				
<i>LET OP! Niet geschikt voor monteren en persen van het Uponor GAS Press systeem</i>				

Expanderen

art.nr.	omschrijving	LE	VPE	eenheid
---------	--------------	----	-----	---------

Uponor Minitec expansiegereedschap



1006247	9,9x1,1	11	1	set
---------	---------	----	---	-----

Uponor Q&E expansiegereedschap met expansiekop M12



1063112	6BAR 9,9/20	-	1	set
1057166	16/20/25 6bar	-	1	set
1057167	16/20/25 10bar	-	1	set

In de koffer bij deze Uponor Q&E accu-expansiemachine M12 zitten de expansiekoppen verpakt voor de diameters en toepassing zoals in de artikelomschrijving staat vermeld.

Uponor Q&E RS expansiegereedschap met expansiekop M12



NEW 1119375	6bar 9,9RS/20	-	1	set
NEW 1119376	16RS/20/25 6bar	-	1	set
NEW 1119379	16RS/20/25 10bar	-	1	set

Uponor Q&E expansiekop M12/Rapid Seal



NEW 1119380	9,9x1.1	-	1	st.
--------------------	---------	---	---	-----

Uponor Q&E expansiekop M12/M18



1057171	12x1,1/1,7/1,8/2,0	-	1	st.
1057184	14/15x2,5	-	1	st.
1057172	16x1,8/2,0/2,2	-	1	st.
1057185	17/18x2,5	-	1	st.
1057173	20x1,9/2,0	-	1	st.
1057174	20x2,8	-	1	st.
1057175	25x2,3	-	1	st.
1057176	25x3,5	-	1	st.
1057177	32x2,9	-	1	st.

Uponor Q&E expansiekop M12/M18/Rapid Seal



NEW 1119381	16x1,8/2,0/2,2	-	1	st.
NEW 1119382	20x1,9/2,0	-	1	st.
NEW 1119383	20x2,8	-	1	st.
NEW 1119384	25x2,3	-	1	st.
NEW 1119385	25x3,5	-	1	st.
NEW 1119386	32x2,9	-	1	st.

Uponor Q&E reserve accu exp.machine M12



1061185	4Ah	12	1	st.
---------	-----	----	---	-----

art.nr.	omschrijving	LE	VPE	eenheid
---------	--------------	----	-----	---------

Uponor Q&E expansiegereedschap m.exp.kop M18 6bar



1063908	16/20/25/32	-	1	set
---------	-------------	---	---	-----

In de koffer bij deze Uponor Q&E accu-expansiemachine M18 zitten de expansiekoppen verpakt voor de diameters en toepassing zoals in de artikelomschrijving staat vermeld.

Uponor Q&E expansiegereedschap m.exp.kop M18 10bar



1063909	16/20/25/H32	-	1	set
---------	--------------	---	---	-----

In de koffer bij deze Uponor Q&E accu-expansiemachine M18 zitten de expansiekoppen verpakt voor de diameters en toepassing zoals in de artikelomschrijving staat vermeld.

Uponor Q&E expansiekop M18 H



1057182	32x2,9/4,4	-	1	st.
1057183	40x3,7	-	1	st.

Uponor Q&E Uponor Q&E exp. gereedschap M18 VLD PEX



1085099	40-75	-	1	st.
---------	-------	---	---	-----

Uponor Q&E expansiekop VLD



1085095	40x3,7/5,5	-	1	st.
1085096	50x4,6/6,9	-	1	st.
1085097	63x5,8/8,6	-	1	st.
1085098	75x6,8/10,3	-	1	st.

Uponor Q&E accu exp. gereedschap M18 PEX



1085100	5,0Ah	-	1	st.
---------	-------	---	---	-----

Uponor Q&E acculader exp. gereedsch. M12/M18 PEX



1085101	220-240V/50-60Hz	-	1	st.
---------	------------------	---	---	-----

Uponor Q&E grafietpasta



1005017	100g	-	1	st.
---------	------	---	---	-----

Bevestigen

art.nr.	omschrijving	LE	VPE	een- heid
---------	--------------	----	-----	--------------

Uponor Siccus 14 polystyreensnijder



1006290	14mm 230V	20	1	st.
---------	-----------	----	---	-----

Uponor Tacker Tool



1119039	14-20mm	50	1	st.
---------	---------	----	---	-----

Uponor Multi plakbandroller



1000142		20	1	st.
---------	--	----	---	-----

Uponor Classic Clipmaster



1006295	16/17mm l=920mm	100	1	st.
---------	-----------------	-----	---	-----

1006309	20mm l=920mm	-	1	st.
---------	--------------	---	---	-----

Uponor Classic drilapparaat voor matbinders



1006243	l=320mm	50	1	st.
---------	---------	----	---	-----

Overige

Uponor Rapex persbek



1006330	14x2	-	1	st.
---------	------	---	---	-----

1006332	16x2	8	1	st.
---------	------	---	---	-----

1006343	17x2	-	1	st.
---------	------	---	---	-----

Uponor Smart Aqua buigtang voor montageplaat



1015424	2m	100	1	st.
---------	----	-----	---	-----

Nieuw 2022

Art.-Nr.	Artikel		Pagina
Artikelnummer oplopend			
1013426	Uponor Minitec klemringschroefkoppeling	9,9-3/4"Euro	33, 41
1085107	Uponor Ecoflex reduceerring	200/160	73
1105818	Uponor S-Press PLUS kniekoppeling met wartel binnendraad	16-G3/4"SN	12
1105819	Uponor S-Press PLUS kniekoppeling met wartel binnendraad	20-G3/4"SN	12
1119375	Uponor Q&E RS expansiegereedschap met expansiekop	M12/ 6bar 9,9RS/20	33, 45, 78
1119376	Uponor Q&E RS expansiegereedschap met expansiekop	M12/ 16RS/20/25 6bar	78
1119379	Uponor Q&E RS expansiegereedschap met expansiekop	M12/ 16RS/20/25 10bar	78
1119380	Uponor Q&E expansiekop	M12/Rapid Seal 9,9x1.1	78
1119381	Uponor Q&E expansiekop	M12/M18/Rapid Seal 16x1,8/2,0/2,2	78
1119382	Uponor Q&E expansiekop	M12/M18/Rapid Seal 20x1,9/2,0	78
1119383	Uponor Q&E expansiekop	M12/M18/Rapid Seal 20x2,8	78
1119384	Uponor Q&E expansiekop	M12/M18/Rapid Seal 25x2,3	78
1119385	Uponor Q&E expansiekop	M12/M18/Rapid Seal 25x3,5	78
1119386	Uponor Q&E expansiekop	M12/M18/Rapid Seal 32x2,9	78
1120123	Uponor Ecoflex Supra PLUS Regelaar 150		69
1120124	Uponor Ecoflex Supra PLUS Set	25+32/68	69
1120126	Uponor Ecoflex Supra PLUS Set	40+50+63/140	69
1120127	Uponor Ecoflex Supra PLUS Set	75/175	69
1120128	Uponor Ecoflex Supra PLUS Set	90+110/200	69
1120408	Uponor Uni Pipe PLUS buigsegment	R32 16	76
1120409	Uponor Uni Pipe PLUS buigsegment	R40 20	76
1120410	Uponor Uni Pipe PLUS buigsegment	R62,5 25	76
1120411	Uponor Uni Pipe PLUS buigsegment	R80 32	76
1121193	Uponor S-Press PLUS geluidset 2 wandpanelen	16-20	12
1121194	Uponor S-Press PLUS geluidset U-muurpaneel	16-20	12
1121195	Uponor S-Press PLUS montagebeugel	80/150mm	14, 21, 26
1121196	Uponor S-Press PLUS montagebeugel	100mm	14, 21, 26
1121197	Uponor S-Press PLUS montageplaat	80/150mm	14, 21, 26
1121531	Uponor Vario M spuitstuk - debietmeter	0-5l/min	52
1122372	Uponor Tacker folie transparant	0,2mm 100x1,03m	39
1087121	Uponor Aqua PLUS verdeler PPM	3X c/c50mm	28
1087122	Uponor Aqua PLUS verdeler PPM	2X c/c50mm	28
1087123	Uponor Aqua PLUS verdeler PPM	1X c/c50mm	28
1087124	Uponor Aqua PLUS verdeler 1+1 PPM	1+1X c/c50mm	28
1096407	Uponor Aqua PLUS afsluitventiel PPM blauw		28
1096408	Uponor Aqua PLUS afsluitventiel PPM rood		28
1087111	Uponor Aqua PLUS Q&E aansluiting PPSU PPM	12	28
1087112	Uponor Aqua PLUS Q&E aansluiting PPSU PPM	16	28
1087113	Uponor Aqua PLUS Q&E aansluiting PPSU PPM	20	28
1087117	Uponor S-Press aansluiting Aqua PLUS PPM	20	28
1119005	Uponor S-Press PLUS aansluiting PPSU	16	28
1087118	Uponor Aqua PLUS aansluiting PL/DR PPM FPL	G1/2"MT	28
1087110	Uponor Aqua PLUS plug PPSU PPM		28
1092669	Uponor Aqua PLUS moersleutel PPM		28
1048002	Uponor Aqua PLUS MT overgang buitendraad PPM	1"	28
1063785	Uponor Aqua PLUS MT overgang binnendraad SN PPM	G3/4"MT	28
1063811	Uponor Aqua PLUS FT overgang binnendraad SN PPM	1"FT-3/4"SN	28
1048003	Uponor Aqua PLUS MT overgangsknie buitendraad PPM	1" G3/4"MT	28
1063782	Uponor Aqua PLUS MT overgangsknie binnendraad PPM	1"MT-1"FT	28
1048004	Uponor Aqua PLUS eindkap PPM	1"FT	28
1048005	Uponor Aqua PLUS ontluchtingseindkap PPM	1"FT	28
1087119	Uponor Aqua PLUS eindplug verdeler PPM	MT	28
1092021	Uponor Aqua PLUS verdelerhouder PPM		28
1087375	Uponor Aqua PLUS PPM		28
1087016	Uponor Aqua PLUS isolatie verdeler EPP	10x c/c50mm l=600	28
1088844	Uponor Aqua PLUS verdelerhouder verzinkt Q&E PPM		28
1087017	Uponor Aqua PLUS kap isolatie verdeler EPP	d=91mm	28

Vervangen

Uitlopend: → → Nieuw Artikel

Art.-Nr.: Levering zolang de voorraad strekt:			Art.-Nr.: Nieuwe Artikel			Pagina
Artikelnummer oplopend						
1023249	Uponor GAS MLC leiding geel op rol	20x2,25 100m	1096433	Uponor GAS leiding geel op rol	SAC 20x2,25 100m	22
1023250	Uponor GAS MLC leiding geel op rol	25x2,5 50m	1096434	Uponor GAS leiding geel op rol	SAC 25x2,5 50m	22
1023251	Uponor GAS MLC leiding geel op rol	32x3,0 50m	1096435	Uponor GAS leiding geel op rol	SAC 32x3,0 50m	22
1083614	Uponor GAS MLC leiding geel	S 20x2,25 5m	1096436	Uponor GAS leiding geel S	SAC 20x2,25 5m	22
1023252	Uponor GAS MLC leiding geel	S 25x2,5 5m	1096437	Uponor GAS leiding geel S	SAC 25x2,5 5m	22
1023253	Uponor GAS MLC leiding geel	S 32x3,0 5m	1096438	Uponor GAS leiding geel S	SAC 32x3,0 5m	22
1023254	Uponor GAS MLC leiding geel in mantelbuis	20x2,25 - 34/29 yellow 75m	1096439	Uponor GAS leiding geel in mantelbuis	SAC 20x2,25 75m	22
			1096439	Uponor GAS leiding geel in mantelbuis	SAC 20x2,25 75m	22
1086527	Uponor Tacker tackerfolie	0,2mm	1122372	Uponor Tacker Folie transparant	0,2mm 100x1,03m	39
1078308	Uponor Fluvia Move pompgroep	CPG-15-A-W	1119445	Uponor Fluvia Move	CPG-15-C-W	
1078309	Uponor Fluvia pompgroep	CPG-15-B-W	1119448	Uponor Fluvia	CPG-15-D-W	
1071685	Uponor Smatrix Wave regelmodule	X-165 6X	1093021	Uponor Smatrix Wave regelmodule	Pulse X-265 6X	58
1071674	Uponor Smatrix Wave PLUS ruimtethermostaat	T-167 grey	1087816	Uponor Smatrix Wave ruimtethermostaat met luchtvochtigheidsensor	Style T-169	58
1071690	Uponor Smatrix Base regelmodule	X-145 Bus 6X	1093017	Uponor Smatrix Base regelmodule	Pulse X-245 BUS 6X	59
1087163	Uponor Smatrix Base PRO regelmoduleset	X-147 + I-147 Bus 6X	1087161	Uponor Smatrix Base PRO bedieningsmodule	I-147 Bus	60
			1087162	Uponor Smatrix Base PRO regelmodule	X-147 Bus 6X	60
1083868	Uponor Ecoflex Thermo	Single 125x11,4/250	1095720	Uponor Ecoflex VIP Thermo	Single 125X11,4/200	68
1088276	Uponor Ecoflex Thermo	Twin 2x75x6,8/250	1118585	Uponor Ecoflex VIP Thermo	Twin 2x75x6,8/250	68
1095575	Uponor Ecoflex Thermo	Mini 32x2,9/68 L=50m	1018133	Uponor Ecoflex Thermo	Mini 32x2,9/68	68
1048697	Uponor Ecoflex Supra PLUS Set	25+32/68	1120124	Uponor Ecoflex Supra PLUS Set	25+32/68	69
1048699	Uponor Ecoflex Supra PLUS Set	40+50+63/140	1120126	Uponor Ecoflex Supra PLUS Set	40+50+63/140	69
1048700	Uponor Ecoflex Supra PLUS Set	75/175	1120127	Uponor Ecoflex Supra PLUS Set	75/175	69
1048702	Uponor Ecoflex Supra PLUS Set	90+110/200	1120128	Uponor Ecoflex Supra PLUS Set	90+110/200	69
1060702	Uponor Q&E expansiekop	M12 9,9x1,1	1119380	Uponor Q&E expansiekop	M12/Rapid Seal 9,9x1.1	78
1002295	Uponor Tacker Tool	14-20mm l=700mm	1119039	Uponor Tacker Tool	14-20mm	40

Installatie

Verwarming en koeling

Warmte- en koudedistributie

Gereedschappen

Bijlage

Artikel is uitlopend:

Levering zolang de voorraad strekt.

Art.-Nr.: Artikel Pagina

Artikelnummer oplopend

1057846	Uponor Smart Aqua geluidsisolatieset	
1060367	Uponor Smart Aqua geluidsisolatieset U-muurplaat	
1057840	Uponor Smart Aqua montageplaat	75/150mm
1057841	Uponor Smart Aqua montagebeugel	80mm
1057839	Uponor Smart Aqua montagebeugel	100mm
1057842	Uponor Smart Aqua montagebeugel	75/150mm
1061622	Uponor Smart Aqua U-muurplaat	RTM 20-Rp1/2"FT-20
1062221	Uponor Smart Aqua U-aansluiting	RTM mixer 16-16-R1/2"MT
1042839	Uponor Q&E ring met stop-edge	red 25
1063932	Uponor Q&E T-stuk	20-14-20
1007234	Uponor Klett plaat	EPS DEO 15mm 2x1m
1090919	Uponor Tacker plaat	EPS DEO 50mm
1090916	Uponor Tacker rol	EPS DEO 26mm 10x1m
1090922	Uponor Tacker rol	EPS DES 25-2mm 10x1m
1090923	Uponor Tacker rol	G EPS DES WLS032 25-2mm 10x1m
1005047	Uponor Classic leidingclip	17mm 3mm
1045814	Uponor Magna verdeelstuk met klep	G3/4
1045813	Uponor Magna verdeelstuk met klep	25
1090262	Uponor Vario PLUS therm. aandrijving PRO	24V 1W NC VA02 MT 30x1,5
1090263	Uponor Vario PLUS thermische aandrijving PRO	230V 1W NC VA02 MT 30x1,5
1090264	Uponor Vario B thermische aandrijving PRO	24V 1W NC VA32 FT 28x1,5
1090265	Uponor Vario B thermische aandrijving PRO	230V 1W NC VA32 FT 28x1,5
1087763	Uponor Vario thermische aandrijving	S 230V
1087778	Uponor Vario thermische aandrijving	S 24V
1085820	Uponor Viva drukverschilregelaar	Rp1 - G1
1030101	Uponor Vario cilinderslot verdelerkast	UP
1071999	Uponor Fluvia T control-Set	Push-12 WL-REC-AC WL-REC-AC
1071686	Uponor Smatrix Base uitbreidingsmodule	M-140 Bus 6X
1071651	Uponor Smatrix Base ster-module	M-141 Bus 8X
1000314	Uponor Space condensschakelaar	TK 1PF 24V

Art.-Nr.: Artikel Pagina

1000312	Uponor Space condensvoeler	TF 3 PR 24V
1000313	Uponor Space condensvoeler	TF 3 GM 24V
1093451	Uponor Comfort E kabel	150W 13m
1093452	Uponor Comfort E kabel	300W 25m
1093453	Uponor Comfort E kabel	460W 37m
1093454	Uponor Comfort E kabel	700W 54m
1093455	Uponor Comfort E kabel	930W 75m
1093456	Uponor Comfort E kabel	1100W 87m
1093457	Uponor Comfort E kabel	1550W 124m
1093458	Uponor Comfort E kabel	1850W 143m
1093460	Uponor Comfort E montage rail	
1088694	Uponor Comfort E AL-folielmat	set T-87IF 140-1
1088695	Uponor Comfort E AL-folielmat	set T-87IF 140-2
1088696	Uponor Comfort E AL-folielmat	set T-87IF 140-3
1088697	Uponor Comfort E AL-folielmat	set T-87IF 140-4
1088698	Uponor Comfort E AL-folielmat	set T-87IF 140-5
1088699	Uponor Comfort E AL-folielmat	set T-87IF 140-6
1088700	Uponor Comfort E AL-folielmat	set T-87IF 140-7
1088701	Uponor Comfort E AL-folielmat	set T-87IF 140-8
1088702	Uponor Comfort E AL-folielmat	set T-87IF 140-9
1088703	Uponor Comfort E AL-folielmat	set T-87IF 140-10
1088684	Uponor Comfort E AL-folielmat	140-1
1088685	Uponor Comfort E AL-folielmat	140-2
1088686	Uponor Comfort E AL-folielmat	140-3
1088687	Uponor Comfort E AL-folielmat	140-4
1088688	Uponor Comfort E AL-folielmat	140-5
1088689	Uponor Comfort E AL-folielmat	140-6
1088690	Uponor Comfort E AL-folielmat	140-7
1088691	Uponor Comfort E AL-folielmat	140-8
1088692	Uponor Comfort E AL-folielmat	140-9
1088693	Uponor Comfort E AL-folielmat	140-10
1088707	Uponor Comfort E AL-folielmat isolatie	5mm
1090942	Uponor Comfort E kabel	R-Set 230V
1090943	Uponor Comfort E mantelbuis	
1083869	Uponor Ecoflex rubberen eindkap	Single 90+110+125/250
1088822	Uponor Ecoflex huisaansluiting haaks	Twin 2x75x6,8/250
1093093	Uponor Smart Aqua montagestrip	S-Press 38/100/153

De complete onlineprijslijst downloaden:



Direct naar het downloaden van de complete prijslijst Benelux 2022 (alleen beschikbaar als pdf-versie).

Aanwijzingen bij de actuele prijslijst

- Alle prijzen zijn vrijblijvende prijsaanbevelingen in euro's exclusief BTW
- Onze verkoop- en leveringsvoorwaarden zijn van toepassing
- Bij het verschijnen van deze prijslijst worden alle voorgaande prijslijsten ongeldig
- De vermelde prijzen zijn af fabriek en exclusief transportverpakking
- Technische en inhoudelijke wijzigingen voorbehouden
- Meer informatie:
www.uponor.nl / www.nathan.nl
www.uponor.be / www.nathan.be

Alle wettelijke en technische informatie werd naar beste weten zorgvuldig samengesteld. Fouten kunnen echter niet volledig worden uitgesloten en hiervoor wordt geen aansprakelijkheid aanvaard. Het werk is inclusief al zijn onderdelen auteursrechtelijk beschermd. Iedere toepassing buiten de door de auteurswet toegestane uitzonderingen is zonder toestemming van Uponor GmbH niet geoorloofd.

Technische wijzigingen voorbehouden.

© 2022

Uponor GmbH, Haßfurt

Moving ➤ Forward

Uponor

Uponor GmbH

Industriestraße 56
97437 Hassfurt
Germany

www.uponor.com



Nathan Systems BV
Mega 2
6902 KL, Zevenaar
Nederland

T +31 (0)26-445 98 45
F +31 (0)26-445 93 73
W www.nathan.nl
E info@nathan.nl

W www.uponor.nl
E info.nl@uponor.com

Nathan Systems NV/SA
Lozenberg 4
1932 Zaventem
België

T +32 (0)2 721 15 70
F +32 (0)2 725 35 53
W www.nathan.be
E info@nathan.be

W www.uponor.be
E info.be@uponor.com